



MEMBER



It's Our Nature. 

VULCRAFT

COMPOSITE DECK
WITH COMPOSITE STUD TABLES

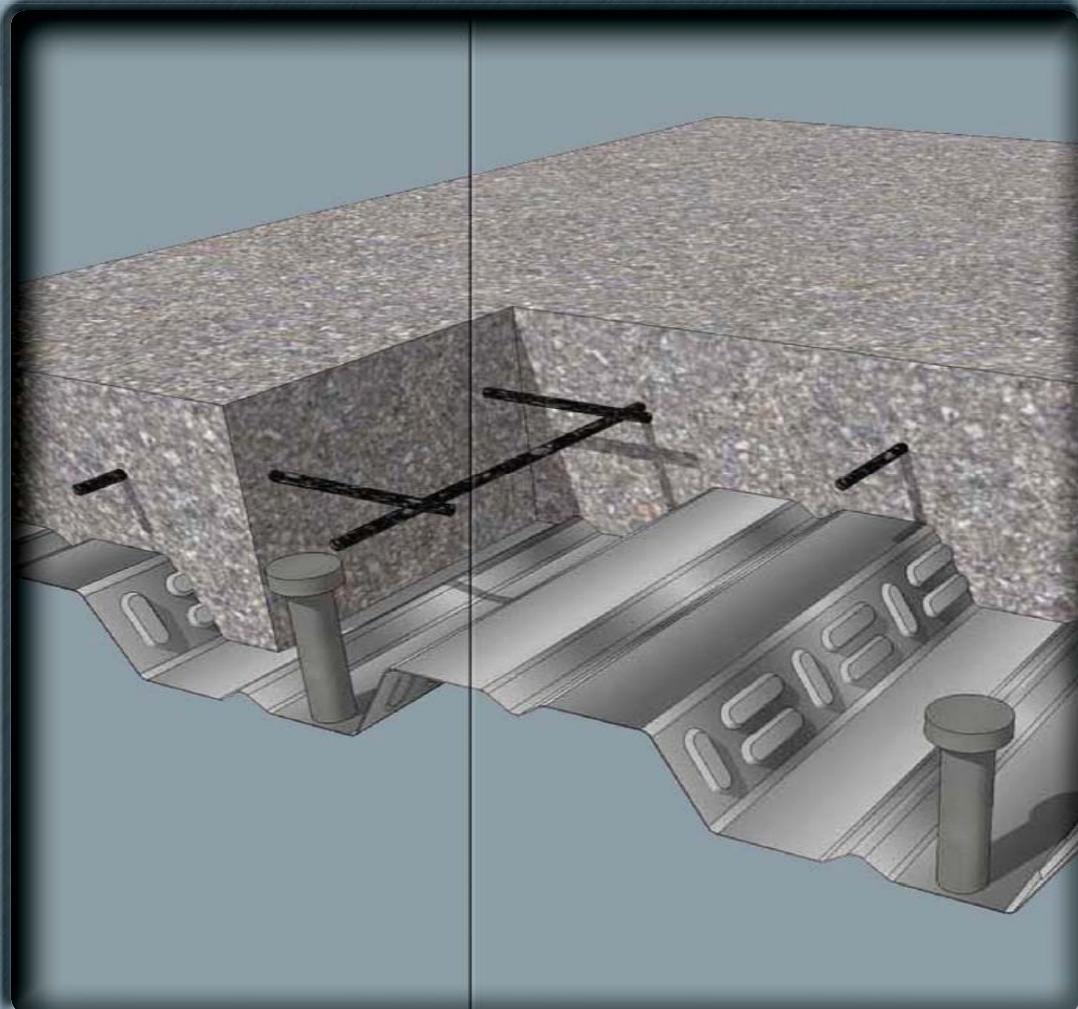

VULCRAFT
2010
STEEL DECK
COMPOSITE

1.5 VL/VLI No Studs

Maximum Sheet Length 42'-0"
Extra charge for lengths under 6'-0"

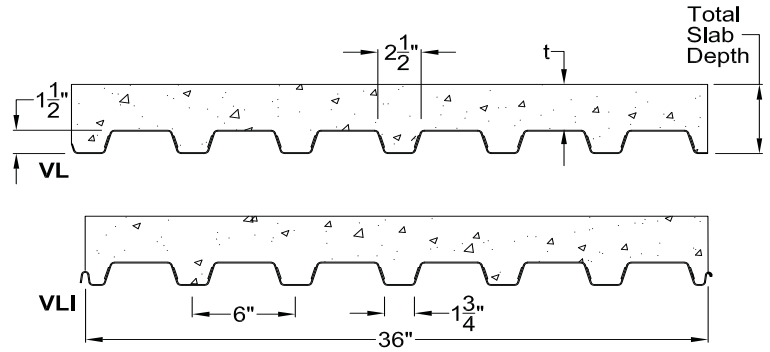

Interlocking side lap is not drawn to show actual detail.

STEEL SECTION PROPERTIES

Deck type	Design thickness (in.)	Weight psf	Section Properties				V _a lbs/ft	F _y ksi
			I _b in ⁴ /ft	S _b in ³ /ft	I _n in ⁴ /ft	S _n in ³ /ft		
1.5VL22	0.0295	1.78	0.143	0.169	0.177	0.179	2626	50
1.5VL20	0.0358	2.14	0.186	0.224	0.222	0.231	3171	50
1.5VL19	0.0418	2.49	0.230	0.271	0.260	0.282	3685	50
1.5VL18	0.0474	2.82	0.272	0.311	0.295	0.324	4160	50
1.5VL16	0.0598	3.54	0.373	0.404	0.373	0.411	4157	40

(N=9.35) NORMAL WEIGHT CONCRETE (145 PCF)

Total Slab Depth	Deck Type	SDI Max. Unshored Clear Span			Superimposed Live Load (PSF) Clear Span (ft.-in.)														
		1 Span	2 Span	3 Span	5'-0	5'-6	6'-0	6'-6	7'-0	7'-6	8'-0	8'-6	9'-0	9'-6	10'-0	10'-6	11'-0	11'-6	12'-0
4.00 (t=2.50) 39 PSF	1.5VL22	5'-6	7'-5	7'-5	366	325	267	239	216	196	179	164	151	139	129	119	111	103	96
	1.5VL20	6'-7	8'-10	8'-11	400	356	319	289	239	217	198	182	167	155	143	133	124	115	108
	1.5VL19	7'-5	9'-9	10'-1	400	383	344	311	283	235	215	197	182	168	156	145	135	126	115
	1.5VL18	8'-1	10'-5	10'-7	400	400	365	330	301	276	254	211	194	180	167	156	145	136	122
	1.5VL16	8'-3	10'-5	10'-9	400	400	365	330	301	276	255	211	194	180	167	155	145	136	127
4.50 (t=3.00) 45 PSF	1.5VL22	5'-3	7'-1	7'-1	400	345	307	275	248	225	205	188	173	159	147	136	127	118	109
	1.5VL20	6'-3	8'-5	8'-6	400	400	366	303	274	249	227	208	192	177	164	152	142	132	123
	1.5VL19	7'-1	9'-3	9'-7	400	400	393	356	325	269	246	226	208	192	179	166	155	144	135
	1.5VL18	7'-8	9'-11	10'-1	400	400	400	378	344	316	262	241	222	206	191	178	166	155	145
	1.5VL16	7'-10	9'-11	10'-3	400	400	400	377	344	315	262	240	222	205	190	177	165	155	145
5.00 (t=3.50) 51 PSF	1.5VL22	5'-0	6'-9	6'-9	400	391	347	311	280	254	232	213	195	180	167	154	143	133	124
	1.5VL20	6'-0	8'-1	8'-2	400	400	400	343	310	281	257	236	217	200	186	172	160	149	139
	1.5VL19	6'-9	8'-10	9'-2	400	400	400	400	335	304	278	255	235	218	202	188	175	163	153
	1.5VL18	7'-3	9'-6	9'-8	400	400	400	400	389	324	297	272	251	233	216	201	187	175	164
	1.5VL16	7'-5	9'-6	9'-10	400	400	400	400	388	323	295	271	250	232	215	200	187	175	164
5.50 (t=4.00) 57 PSF	1.5VL22	4'-10	6'-6	6'-6	400	400	388	348	314	285	260	238	219	202	186	173	160	149	138
	1.5VL20	5'-9	7'-9	7'-10	400	400	400	383	346	314	287	263	243	224	208	193	179	167	156
	1.5VL19	6'-5	8'-6	8'-9	400	400	400	400	374	340	311	286	263	243	226	210	196	183	171
	1.5VL18	7'-0	9'-1	9'-4	400	400	400	400	400	363	331	305	281	260	241	225	210	196	183
	1.5VL16	7'-1	9'-2	9'-5	400	400	400	400	400	361	330	303	279	259	240	224	209	195	183
6.00 (t=4.50) 63 PSF	1.5VL22	4'-8	6'-4	6'-4	400	400	400	385	347	315	288	263	242	223	206	191	178	165	153
	1.5VL20	5'-6	7'-5	7'-6	400	400	400	400	383	348	318	292	269	248	230	213	199	185	173
	1.5VL19	6'-2	8'-2	8'-5	400	400	400	400	400	377	344	316	291	270	250	232	217	202	189
	1.5VL18	6'-8	8'-9	9'-0	400	400	400	400	400	400	367	337	311	288	267	249	232	217	203
	1.5VL16	6'-10	8'-10	9'-1	400	400	400	400	400	399	365	335	309	286	266	248	231	216	202

- Notes:
1. Minimum exterior bearing length required is 1.50 inches. Minimum interior bearing length required is 3.00 inches. If these minimum lengths are not provided, web crippling must be checked.
 2. Always contact Vulcraft when using loads in excess of 200 psf. Such loads often result from concentrated, dynamic, or long term load cases for which reductions due to bond breakage, concrete creep, etc. should be evaluated.
 3. All fire rated assemblies are subject to an upper live load limit of 250 psf.
 4. 3/4 in. diameter welded shear stud utilized for calculations.
 5. Refer to AISC for further stud material and installation requirements.

SLAB INFORMATION

Total Slab Depth, in.	Theoretical Concrete Volume		Recommended Welded Wire Fabric
	Yd ³ / 100 ft ²	ft ³ / ft ²	
3 1/2	0.78	0.211	6x6 - W1.4xW1.4
4	0.94	0.253	6x6 - W1.4xW1.4
4 1/2	1.09	0.294	6x6 - W1.4xW1.4
4 3/4	1.17	0.315	6x6 - W1.4xW1.4
5	1.24	0.336	6x6 - W2.1xW2.1
5 1/2	1.40	0.378	6x6 - W2.1xW2.1
5 3/4	1.48	0.398	6x6 - W2.1xW2.1
6	1.55	0.419	6x6 - W2.1xW2.1

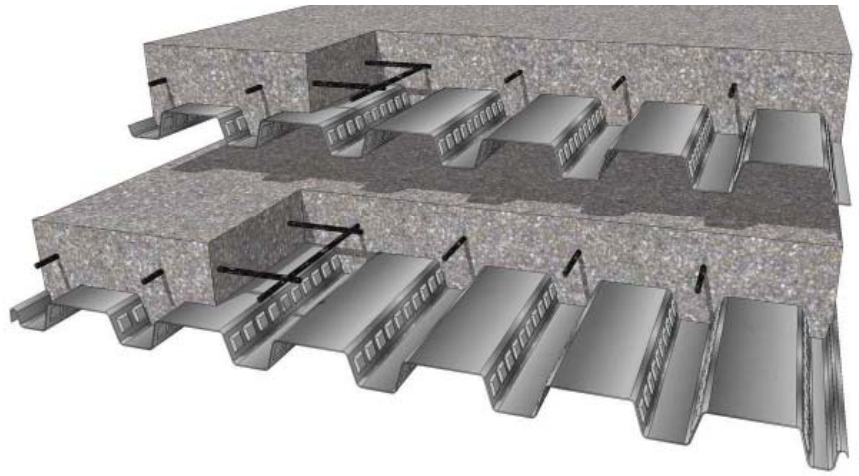

1.5VLI - NO STUDS

(N=14.15) LIGHTWEIGHT CONCRETE (110 PCF)

Total Slab Depth	Deck Type	SDI Max. Unshored Clear Span			Superimposed Live Load (PSF) Clear Span (ft.-in.)														
		1 Span	2 Span	3 Span	5'-0	5'-6	6'-0	6'-6	7'-0	7'-6	8'-0	8'-6	9'-0	9'-6	10'-0	10'-6	11'-0	11'-6	12'-0
4.00 (t=2.50) 30 PSF	1.5VL22	6'-0	8'-1	8'-1	324	288	258	215	194	177	161	148	136	126	113	98	85	75	66
	1.5VL20	7'-3	9'-7	9'-9	355	315	283	256	233	195	178	164	151	140	123	106	92	81	71
	1.5VL19	8'-2	10'-7	10'-11	382	339	304	275	251	230	212	178	164	152	131	113	99	86	76
	1.5VL18	8'-11	11'-4	11'-5	400	360	323	292	266	244	225	209	175	162	139	120	104	91	80
4.50 (t=3.00) 35 PSF	1.5VL22	5'-9	7'-8	7'-8	372	330	275	246	223	202	185	170	156	145	134	125	116	106	93
	1.5VL20	6'-11	9'-2	9'-4	400	361	324	293	246	223	204	188	173	160	149	139	129	114	101
	1.5VL19	7'-9	10'-1	10'-5	400	388	348	315	287	264	221	203	188	174	162	151	140	122	107
	1.5VL18	8'-6	10'-10	11'-0	400	400	369	334	305	279	258	239	200	186	173	161	147	129	114
4.75 (t=3.25) 37 PSF	1.5VL22	5'-7	7'-7	7'-7	396	352	293	263	237	216	197	181	167	154	143	133	124	115	108
	1.5VL20	6'-9	9'-0	9'-1	400	385	345	312	262	238	218	200	184	171	159	148	138	129	118
	1.5VL19	7'-7	9'-11	10'-3	400	400	371	336	306	281	235	216	200	185	172	160	150	140	126
	1.5VL18	8'-3	10'-7	10'-9	400	400	393	356	324	298	274	231	213	198	184	171	160	150	133
5.00 (t=3.50) 39 PSF	1.5VL22	5'-6	7'-5	7'-5	400	374	311	279	252	229	209	192	177	164	152	141	131	123	115
	1.5VL20	6'-7	8'-10	8'-11	400	400	367	332	278	253	231	212	196	181	168	157	146	137	128
	1.5VL19	7'-5	9'-9	10'-0	400	400	394	356	325	273	250	230	212	197	183	170	159	149	140
	1.5VL18	8'-1	10'-5	10'-7	400	400	400	378	344	316	291	245	226	210	195	182	170	159	149
5.75 (t=4.25) 46 PSF	1.5VL22	5'-2	7'-0	7'-0	400	400	367	329	297	270	247	227	209	193	179	166	155	145	135
	1.5VL20	6'-2	8'-4	8'-5	400	400	400	362	327	298	272	250	231	214	199	185	172	161	151
	1.5VL19	7'-0	9'-2	9'-6	400	400	400	400	383	322	295	271	250	232	215	201	187	175	165
	1.5VL18	7'-7	9'-10	10'-0	400	400	400	400	400	372	314	289	267	247	230	214	200	188	176
	1.5VL16	7'-9	9'-10	10'-2	400	400	400	400	400	371	312	287	265	246	229	213	199	187	175

- Notes:
1. Minimum exterior bearing length required is 1.50 inches. Minimum interior bearing length required is 3.00 inches. If these minimum lengths are not provided, web crippling must be checked.
 2. Always contact Vulcraft when using loads in excess of 200 psf. Such loads often result from concentrated, dynamic, or long term load cases for which reductions due to bond breakage, concrete creep, etc. should be evaluated.
 3. All fire rated assemblies are subject to an upper live load limit of 250 psf.
 4. 3/4 in. diameter welded shear stud utilized for calculations.
 5. Refer to AISC for further stud material and installation requirements.

1.5 VL/VLI Stud Spacing - 12in C-C

Maximum Sheet Length 42'-0"
Extra charge for lengths under 6'-0"

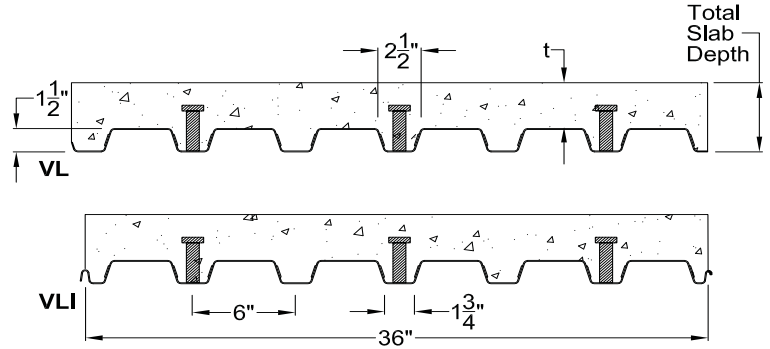

Interlocking side lap is not drawn to show actual detail.

STEEL SECTION PROPERTIES

Deck type	Design thickness (in.)	Weight psf	Section Properties				A _s in ² /ft	ΦV _n lbs/ft	N (Normal Wt. Concrete) studs/ft	N (Lightweight Concrete) studs/ft	F _y ksi
			I _p in ⁴ /ft	S _p in ³ /ft	I _n in ⁴ /ft	S _n in ³ /ft					
1.5VL22	0.0295	1.78	0.143	0.169	0.177	0.179	0.479	3992	0.765	0.818	50
1.5VL20	0.0358	2.14	0.186	0.224	0.222	0.231	0.583	4820	0.928	0.993	50
1.5VL19	0.0418	2.49	0.230	0.271	0.260	0.282	0.682	5602	1.083	1.160	50
1.5VL18	0.0474	2.82	0.272	0.311	0.295	0.324	0.776	6323	1.229	1.315	50
1.5VL16	0.0598	3.54	0.373	0.404	0.373	0.411	0.983	6318	1.240	1.327	40

(N=9.35) NORMAL WEIGHT CONCRETE (145 PCF)

Total Slab Depth	Deck Type	SDI Max. Unshored Clear Span			A _s in ² /ft	ΦV _n lb/ft	Superimposed Live Load (PSF) - Shear Studs at 12 in. c/c Clear Span (ft.-in.)																		
		1 Span	2 Span	3 Span			5'-0"	5'-6"	6'-0"	6'-6"	7'-0"	7'-6"	8'-0"	8'-6"	9'-0"	9'-6"	10'-0"	10'-6"	11'-0"	11'-6"	12'-0"				
4.00 (t=2.50) 39 PSF	1.5VL22	5'-6"	7'-5"	7'-5"	22.16	4127	400	400	400	400	400	400	400	400	380	330	279	235	200	172	148	129	113	99	
	1.5VL20	6'-7"	8'-10"	8'-11"	22.16	4127	400	400	400	400	400	400	400	400	400	363	303	255	217	186	161	140	122	108	
	1.5VL19	7'-5"	9'-9"	10'-1"	22.16	4127	400	399	396	393	391	387	386	324	273	232	199	172	149	131	115				
	1.5VL18	8'-1"	10'-5"	10'-7"	22.16	4127	400	400	393	387	382	377	373	342	289	245	210	182	158	138	122				
	1.5VL16	8'-3"	10'-5"	10'-9"	22.16	4127	400	400	393	386	381	376	372	337	299	267	234	202	176	154	136				
4.50 (t=3.00) 45 PSF	1.5VL22	5'-3"	7'-1"	7'-1"	26.08	4857	400	400	400	400	400	400	400	400	392	343	302	267	237	210	183	160	141		
	1.5VL20	6'-3"	8'-5"	8'-6"	26.08	4857	400	400	400	400	400	400	400	400	400	400	361	307	263	227	198	173	152		
	1.5VL19	7'-1"	9'-3"	9'-7"	26.08	4857	400	400	399	397	394	390	388	387	385	328	281	243	211	185	163				
	1.5VL18	7'-8"	9'-11"	10'-1"	26.08	4857	400	400	400	396	390	384	374	370	367	346	297	257	223	195	172				
	1.5VL16	7'-10"	9'-11"	10'-3"	26.08	4857	400	400	400	396	389	384	373	369	356	318	285	256	232	210	191				
5.00 (t=3.50) 51 PSF	1.5VL22	5'-0"	6'-9"	6'-9"	30.26	5634	400	400	400	400	400	400	400	400	397	350	309	275	245	219	197	177			
	1.5VL20	6'-0"	8'-1"	8'-2"	30.26	5634	400	400	400	400	400	400	400	400	400	400	376	335	300	269	236	208			
	1.5VL19	6'-9"	8'-10"	9'-2"	30.26	5634	400	400	400	400	395	393	391	389	387	386	375	331	288	252	222				
	1.5VL18	7'-3"	9'-6"	9'-8"	30.26	5634	400	400	400	400	398	386	381	376	372	369	366	349	304	266	234				
	1.5VL16	7'-5"	9'-6"	9'-10"	30.26	5634	400	400	400	400	398	385	380	375	371	367	330	297	269	244	221				
5.50 (t=4.00) 57 PSF	1.5VL22	4'-10"	6'-6"	6'-6"	34.68	6459	400	400	400	400	400	400	400	400	397	352	313	279	250	224	201				
	1.5VL20	5'-9"	7'-9"	7'-10"	34.68	6459	400	400	400	400	400	400	400	400	400	400	400	382	342	307	277	250			
	1.5VL19	6'-5"	8'-6"	8'-9"	34.68	6459	400	400	400	400	398	395	393	391	389	388	387	385	347	314	285				
	1.5VL18	7'-0"	9'-1"	9'-4"	34.68	6459	400	400	400	400	400	393	387	382	378	374	370	367	365	336	306				
	1.5VL16	7'-1"	9'-2"	9'-5"	34.68	6459	400	400	400	400	400	392	386	381	377	373	369	338	306	277	252				
6.00 (t=4.50) 63 PSF	1.5VL22	4'-8"	6'-4"	6'-4"	39.37	7331	400	400	400	400	400	400	400	400	400	394	350	313	280	251	225				
	1.5VL20	5'-6"	7'-5"	7'-6"	39.37	7331	400	400	400	400	400	400	400	400	400	400	400	400	384	345	311	281			
	1.5VL19	6'-2"	8'-2"	8'-5"	39.37	7331	400	400	400	400	400	398	396	394	392	390	388	387	386	353	320				
	1.5VL18	6'-8"	8'-9"	9'-0"	39.37	7331	400	400	400	400	400	400	400	394	388	383	379	375	372	369	366	345			
	1.5VL16	6'-10"	8'-10"	9'-1"	39.37	7331	400	400	400	400	400	400	400	393	388	382	378	374	370	343	311	283			

- Notes:
1. Minimum exterior bearing length required is 1.50 inches. Minimum interior bearing length required is 3.00 inches. If these minimum lengths are not provided, web crippling must be checked.
 2. Always contact Vulcraft when using loads in excess of 200 psf. Such loads often result from concentrated, dynamic, or long term load cases for which reductions due to bond breakage, concrete creep, etc. should be evaluated.
 3. All fire rated assemblies are subject to an upper live load limit of 250 psf.
 4. 3/4 in. diameter welded shear stud utilized for calculations.
 5. Refer to AISC for further stud material and installation requirements.

SLAB INFORMATION

Total Slab Depth, in.	Theoretical Concrete Volume		Recommended Welded Wire Fabric
	Yd ³ / 100 ft ²	ft ³ / ft ²	
3 1/2	0.78	0.211	6x6 - W1.4xW1.4
4	0.94	0.253	6x6 - W1.4xW1.4
4 1/2	1.09	0.294	6x6 - W1.4xW1.4
4 3/4	1.17	0.315	6x6 - W1.4xW1.4
5	1.24	0.336	6x6 - W2.1xW2.1
5 1/2	1.40	0.378	6x6 - W2.1xW2.1
5 3/4	1.48	0.398	6x6 - W2.1xW2.1
6	1.55	0.419	6x6 - W2.1xW2.1

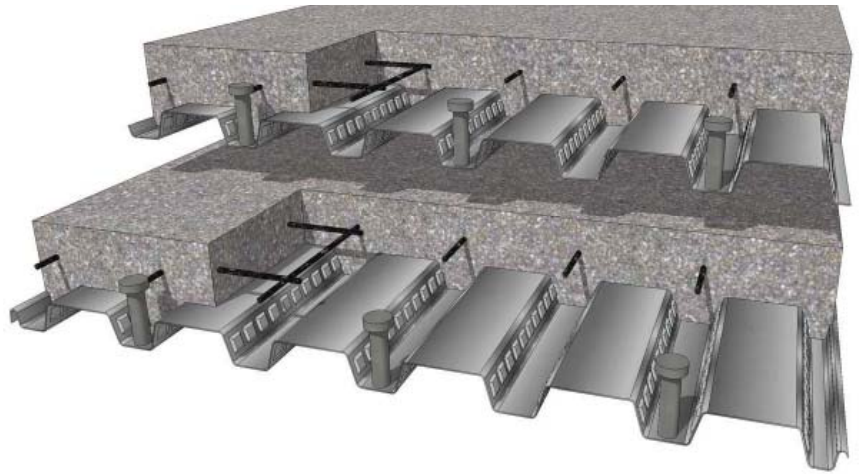

1.5VL/I - 12in C-C

(N=14.15) LIGHTWEIGHT CONCRETE (110 PCF)

Total Slab Depth	Deck Type	SDI Max. Unshored Clear Span			A _c in ² /ft	ΦV _{nt} lb/ft	Superimposed Live Load (PSF) - Shear Studs at 12 in. c/c														
		Clear Span					Clear Span (ft.-in.)														
		1 Span	2 Span	3 Span			5'-0	5'-6	6'-0	6'-6	7'-0	7'-6	8'-0	8'-6	9'-0	9'-6	10'-0	10'-6	11'-0	11'-6	12'-0
4.00 (t=2.50) 30 PSF	1.5VL22	6'-0	8'-1	8'-1	22.16	3096	400	400	400	400	331	269	221	185	156	132	113	98	85	75	66
	1.5VL20	7'-3	9'-7	9'-9	22.16	3096	400	400	400	400	358	291	240	200	168	143	123	106	92	81	71
	1.5VL19	8'-2	10'-7	10'-11	22.16	3096	398	392	387	383	379	311	257	214	180	153	131	113	99	86	76
	1.5VL18	8'-11	11'-4	11'-5	22.16	3096	400	390	381	374	368	329	271	226	191	162	139	120	104	91	80
	1.5VL16	9'-1	11'-4	11'-8	22.16	3096	400	390	381	373	367	362	302	252	212	181	155	134	116	102	90
4.50 (t=3.00) 35 PSF	1.5VL22	5'-9	7'-8	7'-8	26.08	3643	400	400	400	400	400	382	314	262	221	188	161	139	121	106	93
	1.5VL20	6'-11	9'-2	9'-4	26.08	3643	400	400	400	400	400	400	340	283	239	203	174	150	131	114	101
	1.5VL19	7'-9	10'-1	10'-5	26.08	3643	400	398	393	388	384	381	363	302	255	217	186	160	140	122	107
	1.5VL18	8'-6	10'-10	11'-0	26.08	3643	400	400	393	384	377	371	366	320	269	229	196	170	147	129	114
	1.5VL16	8'-7	10'-10	11'-2	26.08	3643	400	400	392	384	376	370	365	355	299	254	218	188	164	143	126
4.75 (t=3.25) 37 PSF	1.5VL22	5'-7	7'-7	7'-7	28.14	3930	400	400	400	400	400	400	369	308	259	221	189	163	142	124	109
	1.5VL20	6'-9	9'-0	9'-1	28.14	3930	400	400	400	400	400	400	399	332	280	238	204	176	153	134	118
	1.5VL19	7'-7	9'-11	10'-3	28.14	3930	400	400	396	391	387	384	377	354	299	254	218	188	164	143	126
	1.5VL18	8'-3	10'-7	10'-9	28.14	3930	400	400	398	389	382	375	370	359	315	268	230	199	173	151	133
	1.5VL16	8'-5	10'-7	11'-0	28.14	3930	400	400	398	389	381	375	369	358	350	298	255	221	192	168	148
5.00 (t=3.50) 39 PSF	1.5VL22	5'-6	7'-5	7'-5	30.26	4226	400	400	400	400	400	400	400	359	302	257	220	190	166	145	127
	1.5VL20	6'-7	8'-10	8'-11	30.26	4226	400	400	400	400	400	400	400	387	326	277	238	205	178	156	137
	1.5VL19	7'-5	9'-9	10'-0	30.26	4226	400	400	399	394	390	383	379	377	347	295	253	219	190	166	146
	1.5VL18	8'-1	10'-5	10'-7	30.26	4226	400	400	400	395	387	380	374	363	358	312	267	231	201	176	155
	1.5VL16	8'-3	10'-5	10'-9	30.26	4226	400	400	400	394	386	379	373	361	357	346	296	256	223	195	171
5.75 (t=4.25) 46 PSF	1.5VL22	5'-2	7'-0	7'-0	36.99	5167	400	400	400	400	400	400	400	400	400	384	334	288	251	220	193
	1.5VL20	6'-2	8'-4	8'-5	36.99	5167	400	400	400	400	400	400	400	400	400	400	359	310	270	236	208
	1.5VL19	7'-0	9'-2	9'-6	36.99	5167	400	400	400	400	398	389	385	382	379	377	375	329	287	251	221
	1.5VL18	7'-7	9'-10	10'-0	36.99	5167	400	400	400	400	400	393	379	373	368	363	359	347	302	264	233
	1.5VL16	7'-9	9'-10	10'-2	36.99	5167	400	400	400	400	400	393	378	372	367	362	358	353	321	292	257

- Notes:
1. Minimum exterior bearing length required is 1.50 inches. Minimum interior bearing length required is 3.00 inches. If these minimum lengths are not provided, web crippling must be checked.
 2. Always contact Vulcraft when using loads in excess of 200 psf. Such loads often result from concentrated, dynamic, or long term load cases for which reductions due to bond breakage, concrete creep, etc. should be evaluated.
 3. All fire rated assemblies are subject to an upper live load limit of 250 psf.
 4. 3/4 in. diameter welded shear stud utilized for calculations.
 5. Refer to AISC for further stud material and installation requirements.

1.5 VL/VLI Stud Spacing - 24in C-C

Maximum Sheet Length 42'-0"
Extra charge for lengths under 6'-0"

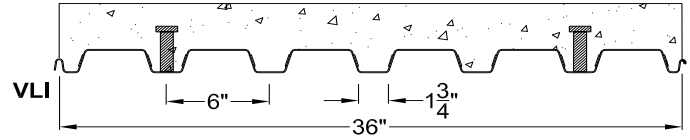
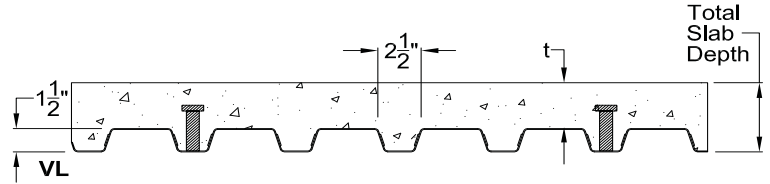

Interlocking side lap is not drawn to show actual detail.

STEEL SECTION PROPERTIES

Deck type	Design thickness (in.)	Weight psf	Section Properties				A _s in ² /ft	ΦV _n lbs/ft	N (Normal Wt. Concrete) studs/ft	N (Lightweight Concrete) studs/ft	F _y ksi
			I _p in ⁴ /ft	S _p in ³ /ft	I _n in ⁴ /ft	S _n in ³ /ft					
1.5VL22	0.0295	1.78	0.143	0.169	0.177	0.179	0.479	3992	0.765	0.818	50
1.5VL20	0.0358	2.14	0.186	0.224	0.222	0.231	0.583	4820	0.928	0.993	50
1.5VL19	0.0418	2.49	0.230	0.271	0.260	0.282	0.682	5602	1.083	1.160	50
1.5VL18	0.0474	2.82	0.272	0.311	0.295	0.324	0.776	6323	1.229	1.315	50
1.5VL16	0.0598	3.54	0.373	0.404	0.373	0.411	0.983	6318	1.240	1.327	40

(N=9.35) NORMAL WEIGHT CONCRETE (145 PCF)

Total Slab Depth	Deck Type	SDI Max. Unshored Clear Span			A _s in ² /ft	ΦV _n lb/ft	Superimposed Live Load (PSF) - Shear Studs at 24 in. c/c Clear Span (ft.-in.)														
		1 Span	2 Span	3 Span			5'-0"	5'-6"	6'-0"	6'-6"	7'-0"	7'-6"	8'-0"	8'-6"	9'-0"	9'-6"	10'-0"	10'-6"	11'-0"	11'-6"	12'-0"
4.00 (t=2.50) 39 PSF	1.5VL22	5'-6"	7'-5"	7'-5"	22.16	4127	388	374	354	344	336	316	278	246	218	195	172	148	129	113	99
	1.5VL20	6'-7"	8'-10"	8'-11"	22.16	4127	400	380	363	349	326	316	304	271	242	217	186	161	140	122	108
	1.5VL19	7'-5"	9'-9"	10'-1"	22.16	4127	400	391	370	352	337	311	300	290	260	232	199	172	149	131	115
	1.5VL18	8'-1"	10'-5"	10'-7"	22.16	4127	400	400	379	358	341	326	314	288	274	245	210	182	158	138	122
	1.5VL16	8'-3"	10'-5"	10'-9"	22.16	4127	400	400	379	358	341	326	313	274	247	224	203	186	170	154	136
4.50 (t=3.00) 45 PSF	1.5VL22	5'-3"	7'-1"	7'-1"	26.08	4857	400	381	368	357	347	339	327	289	257	230	206	186	168	152	137
	1.5VL20	6'-3"	8'-5"	8'-6"	26.08	4857	400	400	384	355	342	330	320	312	285	256	231	209	190	173	152
	1.5VL19	7'-1"	9'-3"	9'-7"	26.08	4857	400	400	396	376	359	330	317	306	297	276	250	228	208	185	163
	1.5VL18	7'-8"	9'-11"	10'-1"	26.08	4857	400	400	400	387	367	350	318	306	295	285	266	242	222	195	172
	1.5VL16	7'-10"	9'-11"	10'-3"	26.08	4857	400	400	400	386	366	349	317	305	289	261	238	217	199	182	168
5.00 (t=3.50) 51 PSF	1.5VL22	5'-0"	6'-9"	6'-9"	30.26	5634	400	397	382	369	359	350	342	333	296	265	238	214	193	175	158
	1.5VL20	6'-0"	8'-1"	8'-2"	30.26	5634	400	400	400	374	358	345	334	324	316	295	266	241	219	200	182
	1.5VL19	6'-9"	8'-10"	9'-2"	30.26	5634	400	400	400	400	365	348	334	322	311	302	289	262	239	219	201
	1.5VL18	7'-3"	9'-6"	9'-8"	30.26	5634	400	400	400	400	393	355	339	324	312	301	291	279	256	235	216
	1.5VL16	7'-5"	9'-6"	9'-10"	30.26	5634	400	400	400	400	393	354	337	323	311	299	272	249	228	209	192
5.50 (t=4.00) 57 PSF	1.5VL22	4'-10"	6'-6"	6'-6"	34.68	6459	400	400	396	382	370	360	351	344	336	300	269	242	219	198	179
	1.5VL20	5'-9"	7'-9"	7'-10"	34.68	6459	400	400	400	392	375	361	348	337	327	319	302	273	248	226	207
	1.5VL19	6'-5"	8'-6"	8'-9"	34.68	6459	400	400	400	400	386	368	352	338	326	316	306	297	271	248	228
	1.5VL18	7'-0"	9'-1"	9'-4"	34.68	6459	400	400	400	400	400	378	359	343	329	317	306	296	287	266	245
	1.5VL16	7'-1"	9'-2"	9'-5"	34.68	6459	400	400	400	400	400	377	358	342	328	316	305	281	257	236	217
6.00 (t=4.50) 63 PSF	1.5VL22	4'-8"	6'-4"	6'-4"	39.37	7331	400	400	400	395	382	371	361	353	345	335	301	271	244	221	201
	1.5VL20	5'-6"	7'-5"	7'-6"	39.37	7331	400	400	400	400	392	376	362	350	339	330	322	305	278	253	231
	1.5VL19	6'-2"	8'-2"	8'-5"	39.37	7331	400	400	400	400	400	388	370	355	342	330	319	310	301	278	255
	1.5VL18	6'-8"	8'-9"	9'-0"	39.37	7331	400	400	400	400	400	400	380	363	347	333	321	310	300	291	274
	1.5VL16	6'-10"	8'-10"	9'-1"	39.37	7331	400	400	400	400	400	400	379	361	346	332	320	309	287	263	243

- Notes:
1. Minimum exterior bearing length required is 1.50 inches. Minimum interior bearing length required is 3.00 inches. If these minimum lengths are not provided, web crippling must be checked.
 2. Always contact Vulcraft when using loads in excess of 200 psf. Such loads often result from concentrated, dynamic, or long term load cases for which reductions due to bond breakage, concrete creep, etc. should be evaluated.
 3. All fire rated assemblies are subject to an upper live load limit of 250 psf.
 4. 3/4 in. diameter welded shear stud utilized for calculations.
 5. Refer to AISC for further stud material and installation requirements.

SLAB INFORMATION

Total Slab Depth, in.	Theoretical Concrete Volume		Recommended Welded Wire Fabric
	Yd ³ / 100 ft ²	ft ³ / ft ²	
3 1/2	0.78	0.211	6x6 - W1.4xW1.4
4	0.94	0.253	6x6 - W1.4xW1.4
4 1/2	1.09	0.294	6x6 - W1.4xW1.4
4 3/4	1.17	0.315	6x6 - W1.4xW1.4
5	1.24	0.336	6x6 - W2.1xW2.1
5 1/2	1.40	0.378	6x6 - W2.1xW2.1
5 3/4	1.48	0.398	6x6 - W2.1xW2.1
6	1.55	0.419	6x6 - W2.1xW2.1

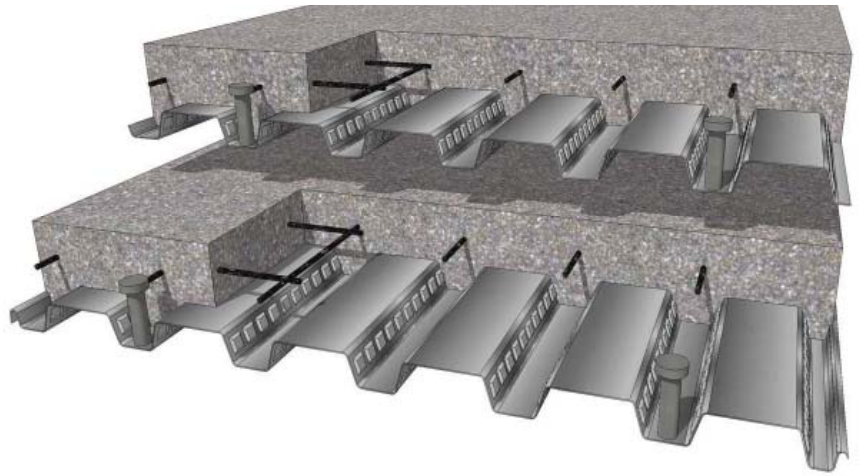

1.5VL/I - 24in C-C

(N=14.15) LIGHTWEIGHT CONCRETE (110 PCF)

Total Slab Depth	Deck Type	SDI Max. Unshored Clear Span			A _c in ² /ft	ΦV _{nt} lb/ft	Superimposed Live Load (PSF) - Shear Studs at 24 in. c/c														
		Clear Span					Clear Span (ft.-in.)														
		1 Span	2 Span	3 Span			5'-0	5'-6	6'-0	6'-6	7'-0	7'-6	8'-0	8'-6	9'-0	9'-6	10'-0	10'-6	11'-0	11'-6	12'-0
4.00 (t=2.50) 30 PSF	1.5VL22	6'-0	8'-1	8'-1	22.16	3096	370	356	345	328	320	269	221	185	156	132	113	98	85	75	66
	1.5VL20	7'-3	9'-7	9'-9	22.16	3096	378	358	342	328	317	291	240	200	168	143	123	106	92	81	71
	1.5VL19	8'-2	10'-7	10'-11	22.16	3096	390	365	345	329	315	303	257	214	180	153	131	113	99	86	76
	1.5VL18	8'-11	11'-4	11'-5	22.16	3096	400	375	352	333	317	303	271	226	191	162	139	120	104	91	80
	1.5VL16	9'-1	11'-4	11'-8	22.16	3096	400	375	352	333	317	303	291	252	212	181	155	134	116	102	90
4.50 (t=3.00) 35 PSF	1.5VL22	5'-9	7'-8	7'-8	26.08	3643	389	373	351	340	331	323	314	262	221	188	161	139	121	106	93
	1.5VL20	6'-11	9'-2	9'-4	26.08	3643	400	381	362	347	323	312	303	283	239	203	174	150	131	114	101
	1.5VL19	7'-9	10'-1	10'-5	26.08	3643	400	393	371	352	336	322	298	288	255	217	186	160	140	122	107
	1.5VL18	8'-6	10'-10	11'-0	26.08	3643	400	400	381	359	341	325	312	300	269	229	196	170	147	129	114
	1.5VL16	8'-7	10'-10	11'-2	26.08	3643	400	400	381	359	340	325	311	299	273	248	218	188	164	143	126
4.75 (t=3.25) 37 PSF	1.5VL22	5'-7	7'-7	7'-7	28.14	3930	399	381	358	347	337	328	321	302	259	221	189	163	142	124	109
	1.5VL20	6'-9	9'-0	9'-1	28.14	3930	400	393	373	356	331	320	309	301	280	238	204	176	153	134	118
	1.5VL19	7'-7	9'-11	10'-3	28.14	3930	400	400	384	363	347	332	306	296	286	254	218	188	164	143	126
	1.5VL18	8'-3	10'-7	10'-9	28.14	3930	400	400	396	373	353	336	322	295	284	268	230	199	173	151	133
	1.5VL16	8'-5	10'-7	11'-0	28.14	3930	400	400	395	372	352	336	321	294	283	266	242	221	192	168	148
5.00 (t=3.50) 39 PSF	1.5VL22	5'-6	7'-5	7'-5	30.26	4226	400	390	365	353	342	334	326	319	288	257	220	190	166	145	127
	1.5VL20	6'-7	8'-10	8'-11	30.26	4226	400	400	383	366	339	327	316	307	299	277	238	205	178	156	137
	1.5VL19	7'-5	9'-9	10'-0	30.26	4226	400	400	397	375	357	328	315	303	293	284	253	219	190	166	146
	1.5VL18	8'-1	10'-5	10'-7	30.26	4226	400	400	400	386	365	348	333	304	292	282	267	231	201	176	155
	1.5VL16	8'-3	10'-5	10'-9	30.26	4226	400	400	400	385	365	347	332	303	291	281	259	237	218	195	171
5.75 (t=4.25) 46 PSF	1.5VL22	5'-2	7'-0	7'-0	36.99	5167	400	400	387	372	360	349	340	333	326	310	279	253	229	209	191
	1.5VL20	6'-2	8'-4	8'-5	36.99	5167	400	400	400	381	364	349	337	326	316	308	300	280	256	234	208
	1.5VL19	7'-0	9'-2	9'-6	36.99	5167	400	400	400	400	390	356	340	327	315	304	295	287	276	251	221
	1.5VL18	7'-7	9'-10	10'-0	36.99	5167	400	400	400	400	400	383	346	331	317	305	294	285	276	264	233
	1.5VL16	7'-9	9'-10	10'-2	36.99	5167	400	400	400	400	400	382	345	330	316	304	293	283	260	239	221

- Notes:
1. Minimum exterior bearing length required is 1.50 inches. Minimum interior bearing length required is 3.00 inches. If these minimum lengths are not provided, web crippling must be checked.
 2. Always contact Vulcraft when using loads in excess of 200 psf. Such loads often result from concentrated, dynamic, or long term load cases for which reductions due to bond breakage, concrete creep, etc. should be evaluated.
 3. All fire rated assemblies are subject to an upper live load limit of 250 psf.
 4. 3/4 in. diameter welded shear stud utilized for calculations.
 5. Refer to AISC for further stud material and installation requirements.

1.5 VL/VLI Stud Spacing - 36in C-C

Maximum Sheet Length 42'-0"
Extra charge for lengths under 6'-0"

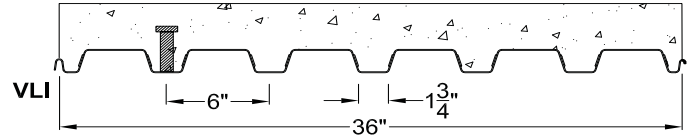
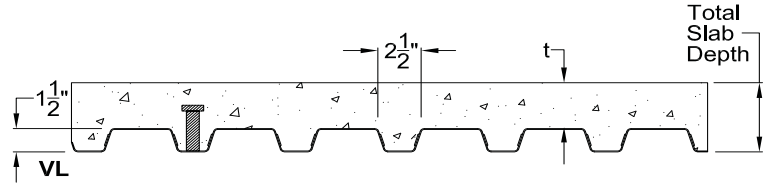

Interlocking side lap is not drawn to show actual detail.

STEEL SECTION PROPERTIES

Deck type	Design thickness (in.)	Weight psf	Section Properties				A _s in ² /ft	ΦV _n lbs/ft	N (Normal Wt. Concrete) studs/ft	N (Lightweight Concrete) studs/ft	F _y ksi
			I _p in ⁴ /ft	S _p in ³ /ft	I _n in ⁴ /ft	S _n in ³ /ft					
1.5VL22	0.0295	1.78	0.143	0.169	0.177	0.179	0.479	3992	0.765	0.818	50
1.5VL20	0.0358	2.14	0.186	0.224	0.222	0.231	0.583	4820	0.928	0.993	50
1.5VL19	0.0418	2.49	0.230	0.271	0.260	0.282	0.682	5602	1.083	1.160	50
1.5VL18	0.0474	2.82	0.272	0.311	0.295	0.324	0.776	6323	1.229	1.315	50
1.5VL16	0.0598	3.54	0.373	0.404	0.373	0.411	0.983	6318	1.240	1.327	40

(N=9.35) NORMAL WEIGHT CONCRETE (145 PCF)

Total Slab Depth	Deck Type	SDI Max. Unshored Clear Span			A _s in ² /ft	ΦV _n lb/ft	Superimposed Live Load (PSF) - Shear Studs at 36 in. c/c Clear Span (ft.-in.)														
		1 Span	2 Span	3 Span			5'-0"	5'-6"	6'-0"	6'-6"	7'-0"	7'-6"	8'-0"	8'-6"	9'-0"	9'-6"	10'-0"	10'-6"	11'-0"	11'-6"	12'-0"
4.00 (t=2.50) 39 PSF	1.5VL22	5'-6"	7'-5"	7'-5"	22.16	4127	381	358	325	309	296	276	245	218	196	176	160	145	129	113	99
	1.5VL20	6'-7"	8'-10"	8'-11"	22.16	4127	400	372	348	329	297	283	269	241	217	196	179	161	140	122	108
	1.5VL19	7'-5"	9'-9"	10'-1"	22.16	4127	400	388	361	338	319	286	272	259	234	212	194	172	149	131	115
	1.5VL18	8'-1"	10'-5"	10'-7"	22.16	4127	400	400	374	349	328	310	294	262	248	226	206	182	158	138	122
	1.5VL16	8'-3"	10'-5"	10'-9"	22.16	4127	400	400	374	349	328	309	294	253	229	209	191	175	162	149	136
4.50 (t=3.00) 45 PSF	1.5VL22	5'-3"	7'-1"	7'-1"	26.08	4857	400	369	347	329	314	301	286	255	229	206	187	169	154	140	128
	1.5VL20	6'-3"	8'-5"	8'-6"	26.08	4857	400	400	378	338	319	303	289	277	254	230	209	190	174	160	147
	1.5VL19	7'-1"	9'-3"	9'-7"	26.08	4857	400	400	395	370	348	309	293	279	267	248	226	207	190	175	161
	1.5VL18	7'-8"	9'-11"	10'-1"	26.08	4857	400	400	400	384	359	339	300	284	271	258	241	221	203	187	172
	1.5VL16	7'-10"	9'-11"	10'-3"	26.08	4857	400	400	400	383	359	338	299	283	266	243	222	204	187	173	160
5.00 (t=3.50) 51 PSF	1.5VL22	5'-0"	6'-9"	6'-9"	30.26	5634	400	395	370	350	333	318	305	293	263	237	214	194	176	161	147
	1.5VL20	6'-0"	8'-1"	8'-2"	30.26	5634	400	400	400	363	342	324	308	295	283	263	239	218	200	183	168
	1.5VL19	6'-9"	8'-10"	9'-2"	30.26	5634	400	400	400	400	355	334	316	300	286	274	260	238	218	200	185
	1.5VL18	7'-3"	9'-6"	9'-8"	30.26	5634	400	400	400	400	392	345	325	307	292	278	266	253	233	215	199
	1.5VL16	7'-5"	9'-6"	9'-10"	30.26	5634	400	400	400	400	391	344	323	306	290	277	253	232	214	198	183
5.50 (t=4.00) 57 PSF	1.5VL22	4'-10"	6'-6"	6'-6"	34.68	6459	400	400	393	371	351	335	321	309	297	267	241	219	199	182	166
	1.5VL20	5'-9"	7'-9"	7'-10"	34.68	6459	400	400	400	389	366	345	328	312	299	287	270	246	225	207	190
	1.5VL19	6'-5"	8'-6"	8'-9"	34.68	6459	400	400	400	400	382	359	338	321	305	292	279	268	246	226	209
	1.5VL18	7'-0"	9'-1"	9'-4"	34.68	6459	400	400	400	400	400	373	350	330	313	298	284	272	261	243	224
	1.5VL16	7'-1"	9'-2"	9'-5"	34.68	6459	400	400	400	400	400	371	349	329	312	297	283	262	241	222	206
6.00 (t=4.50) 63 PSF	1.5VL22	4'-8"	6'-4"	6'-4"	39.37	7331	400	400	400	392	370	352	337	323	311	298	269	244	222	202	185
	1.5VL20	5'-6"	7'-5"	7'-6"	39.37	7331	400	400	400	400	389	367	348	331	316	303	291	275	251	230	212
	1.5VL19	6'-2"	8'-2"	8'-5"	39.37	7331	400	400	400	400	400	384	362	342	325	310	296	284	273	253	233
	1.5VL18	6'-8"	8'-9"	9'-0"	39.37	7331	400	400	400	400	400	400	376	354	335	318	303	290	278	267	250
	1.5VL16	6'-10"	8'-10"	9'-1"	39.37	7331	400	400	400	400	400	400	375	353	334	317	302	289	268	248	229

- Notes:
1. Minimum exterior bearing length required is 1.50 inches. Minimum interior bearing length required is 3.00 inches. If these minimum lengths are not provided, web crippling must be checked.
 2. Always contact Vulcraft when using loads in excess of 200 psf. Such loads often result from concentrated, dynamic, or long term load cases for which reductions due to bond breakage, concrete creep, etc. should be evaluated.
 3. All fire rated assemblies are subject to an upper live load limit of 250 psf.
 4. 3/4 in. diameter welded shear stud utilized for calculations.
 5. Refer to AISC for further stud material and installation requirements.

SLAB INFORMATION

Total Slab Depth, in.	Theoretical Concrete Volume		Recommended Welded Wire Fabric
	Yd ³ / 100 ft ²	ft ³ / ft ²	
3 1/2	0.78	0.211	6x6 - W1.4xW1.4
4	0.94	0.253	6x6 - W1.4xW1.4
4 1/2	1.09	0.294	6x6 - W1.4xW1.4
4 3/4	1.17	0.315	6x6 - W1.4xW1.4
5	1.24	0.336	6x6 - W2.1xW2.1
5 1/2	1.40	0.378	6x6 - W2.1xW2.1
5 3/4	1.48	0.398	6x6 - W2.1xW2.1
6	1.55	0.419	6x6 - W2.1xW2.1

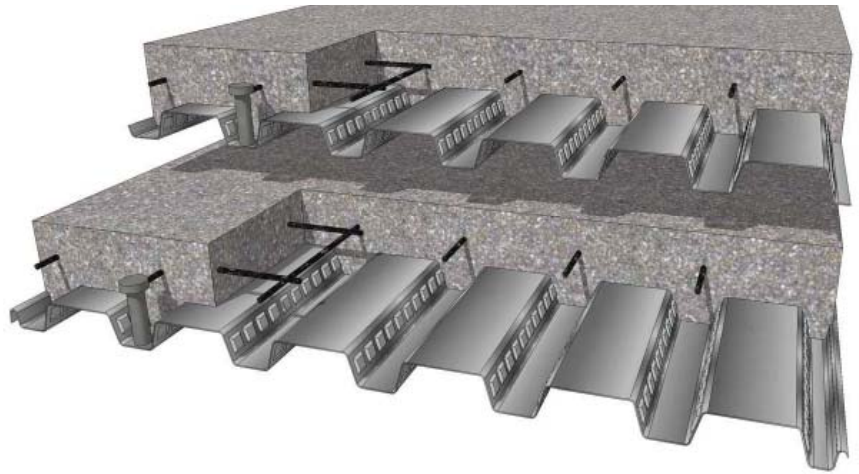

1.5VL/I - 36in C-C

(N=14.15) LIGHTWEIGHT CONCRETE (110 PCF)

Total Slab Depth	Deck Type	SDI Max. Unshored Clear Span			A _c in ² /ft	ΦV _{nt} lb/ft	Superimposed Live Load (PSF) - Shear Studs at 36 in. c/c														
		Clear Span (ft.-in.)																			
		1 Span	2 Span	3 Span			5'-0	5'-6	6'-0	6'-6	7'-0	7'-6	8'-0	8'-6	9'-0	9'-6	10'-0	10'-6	11'-0	11'-6	12'-0
4.00 (t=2.50) 30 PSF	1.5VL22	6'-0	8'-1	8'-1	22.16	3096	355	333	316	290	278	262	221	185	156	132	113	98	85	75	66
	1.5VL20	7'-3	9'-7	9'-9	22.16	3096	370	344	322	304	289	264	240	200	168	143	123	106	92	81	71
	1.5VL19	8'-2	10'-7	10'-11	22.16	3096	387	357	332	311	294	279	257	214	180	153	131	113	99	86	76
	1.5VL18	8'-11	11'-4	11'-5	22.16	3096	400	370	342	319	300	284	270	226	191	162	139	120	104	91	80
	1.5VL16	9'-1	11'-4	11'-8	22.16	3096	400	370	342	319	300	283	269	251	212	181	155	134	116	102	90
4.50 (t=3.00) 35 PSF	1.5VL22	5'-9	7'-8	7'-8	26.08	3643	383	359	326	309	295	283	272	244	219	188	161	139	121	106	93
	1.5VL20	6'-11	9'-2	9'-4	26.08	3643	400	374	350	329	297	283	270	259	239	203	174	150	131	114	101
	1.5VL19	7'-9	10'-1	10'-5	26.08	3643	400	392	363	340	320	303	273	260	249	217	186	160	140	122	107
	1.5VL18	8'-6	10'-10	11'-0	26.08	3643	400	400	377	351	329	310	294	280	251	229	196	170	147	129	114
	1.5VL16	8'-7	10'-10	11'-2	26.08	3643	400	400	377	350	328	309	293	279	249	227	208	188	164	143	126
4.75 (t=3.25) 37 PSF	1.5VL22	5'-7	7'-7	7'-7	28.14	3930	398	371	336	319	304	291	280	261	235	212	189	163	142	124	109
	1.5VL20	6'-9	9'-0	9'-1	28.14	3930	400	390	364	342	308	292	279	267	257	234	204	176	153	134	118
	1.5VL19	7'-7	9'-11	10'-3	28.14	3930	400	400	379	354	333	315	283	269	257	247	218	188	164	143	126
	1.5VL18	8'-3	10'-7	10'-9	28.14	3930	400	400	395	367	344	324	306	274	260	249	230	199	173	151	133
	1.5VL16	8'-5	10'-7	11'-0	28.14	3930	400	400	394	366	343	323	306	273	259	243	223	205	189	168	148
5.00 (t=3.50) 39 PSF	1.5VL22	5'-6	7'-5	7'-5	30.26	4226	400	384	347	328	312	299	287	277	251	227	206	188	166	145	127
	1.5VL20	6'-7	8'-10	8'-11	30.26	4226	400	400	378	355	319	302	288	275	264	250	228	205	178	156	137
	1.5VL19	7'-5	9'-9	10'-0	30.26	4226	400	400	396	369	346	310	293	279	266	255	245	219	190	166	146
	1.5VL18	8'-1	10'-5	10'-7	30.26	4226	400	400	400	383	358	337	319	284	270	258	247	231	201	176	155
	1.5VL16	8'-3	10'-5	10'-9	30.26	4226	400	400	400	383	358	336	318	283	269	257	237	218	201	186	171
5.75 (t=4.25) 46 PSF	1.5VL22	5'-2	7'-0	7'-0	36.99	5167	400	400	380	358	339	323	309	297	287	271	246	224	205	187	172
	1.5VL20	6'-2	8'-4	8'-5	36.99	5167	400	400	400	375	352	332	315	301	288	276	266	248	228	210	193
	1.5VL19	7'-0	9'-2	9'-6	36.99	5167	400	400	400	400	388	344	325	308	293	280	268	258	247	228	211
	1.5VL18	7'-7	9'-10	10'-0	36.99	5167	400	400	400	400	400	379	336	317	300	286	273	261	251	241	225
	1.5VL16	7'-9	9'-10	10'-2	36.99	5167	400	400	400	400	400	378	334	315	299	284	272	260	240	222	206

- Notes:
1. Minimum exterior bearing length required is 1.50 inches. Minimum interior bearing length required is 3.00 inches. If these minimum lengths are not provided, web crippling must be checked.
 2. Always contact Vulcraft when using loads in excess of 200 psf. Such loads often result from concentrated, dynamic, or long term load cases for which reductions due to bond breakage, concrete creep, etc. should be evaluated.
 3. All fire rated assemblies are subject to an upper live load limit of 250 psf.
 4. 3/4 in. diameter welded shear stud utilized for calculations.
 5. Refer to AISC for further stud material and installation requirements.

1.5 VLR No Studs

Maximum Sheet Length 42'-0"
Extra charge for lengths under 6'-0"

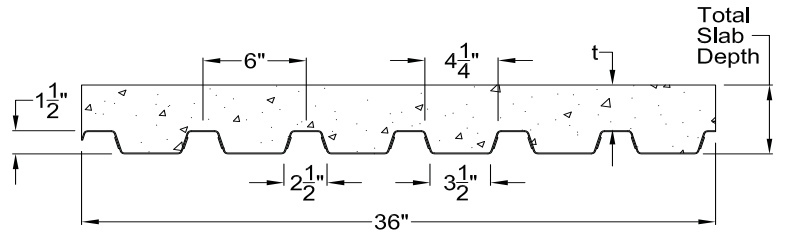

Interlocking side lap is not drawn to show actual detail.

STEEL SECTION PROPERTIES

Deck type	Design thickness (in.)	Weight psf	Section Properties				V _a lbs/ft	F _y ksi
			I _p in ⁴ /ft	S _p in ³ /ft	I _n in ⁴ /ft	S _n in ³ /ft		
1.5VLR22	0.0295	1.78	0.177	0.179	0.143	0.169	2626	50
1.5VLR20	0.0358	2.14	0.222	0.231	0.186	0.224	3171	50
1.5VLR19	0.0418	2.49	0.260	0.282	0.230	0.271	3685	50
1.5VLR18	0.0474	2.82	0.295	0.324	0.272	0.311	4160	50
1.5VLR16	0.0598	3.54	0.373	0.411	0.373	0.404	4157	40

(N=9.35) NORMAL WEIGHT CONCRETE (145 PCF)

Total Slab Depth	Deck Type	SDI Max. Unshored Clear Span			Superimposed Live Load (PSF) Clear Span (ft.-in.)														
		1 Span	2 Span	3 Span	5'-0	5'-6	6'-0	6'-6	7'-0	7'-6	8'-0	8'-6	9'-0	9'-6	10'-0	10'-6	11'-0	11'-6	12'-0
4.00 (t=2.50) 44 PSF	1.5VLR22	5'-6	7'-3	7'-5	366	325	264	236	213	193	176	161	147	136	125	116	107	100	93
	1.5VLR20	6'-5	8'-4	8'-8	400	356	319	261	236	214	195	179	164	151	140	130	121	112	105
	1.5VLR19	7'-3	9'-2	9'-6	400	383	344	311	283	232	212	194	179	165	153	142	132	123	115
	1.5VLR18	7'-11	9'-9	10'-1	400	400	365	330	301	276	226	207	191	177	164	152	142	132	124
	1.5VLR16	7'-11	9'-11	10'-3	400	400	365	330	301	276	226	207	191	176	164	152	142	132	124
4.50 (t=3.00) 50 PSF	1.5VLR22	5'-3	6'-11	7'-1	400	342	303	271	245	222	202	185	170	156	144	133	124	115	107
	1.5VLR20	6'-2	8'-0	8'-3	400	400	366	300	270	245	224	205	188	174	161	149	139	129	120
	1.5VLR19	6'-11	8'-9	9'-1	400	400	393	356	293	266	243	223	205	189	175	163	151	141	132
	1.5VLR18	7'-6	9'-4	9'-8	400	400	400	378	344	316	259	238	219	202	188	174	163	152	142
	1.5VLR16	7'-7	9'-6	9'-10	400	400	400	377	344	315	258	237	218	202	187	174	162	151	141
5.00 (t=3.50) 56 PSF	1.5VLR22	5'-0	6'-8	6'-10	400	387	344	308	277	251	229	209	192	177	164	151	140	130	121
	1.5VLR20	5'-10	7'-8	7'-11	400	400	379	339	306	278	254	232	214	197	182	169	157	146	136
	1.5VLR19	6'-7	8'-5	8'-8	400	400	400	400	331	301	275	252	232	214	199	184	172	160	149
	1.5VLR18	7'-2	9'-0	9'-3	400	400	400	400	389	321	293	269	248	229	213	198	184	172	161
	1.5VLR16	7'-3	9'-1	9'-5	400	400	400	400	388	320	292	268	247	228	212	197	183	171	160
5.50 (t=4.00) 62 PSF	1.5VLR22	4'-10	6'-5	6'-7	400	400	385	344	310	281	256	235	216	199	183	170	157	146	136
	1.5VLR20	5'-8	7'-4	7'-7	400	400	400	380	343	311	284	260	239	221	204	190	176	164	153
	1.5VLR19	6'-4	8'-1	8'-4	400	400	400	400	371	337	308	282	260	240	222	207	192	179	168
	1.5VLR18	6'-11	8'-8	8'-11	400	400	400	400	395	359	328	301	278	257	238	221	206	193	180
	1.5VLR16	6'-11	8'-9	9'-1	400	400	400	400	393	357	327	300	276	255	237	220	205	192	179
6.00 (t=4.50) 68 PSF	1.5VLR22	4'-8	6'-2	6'-4	400	400	400	382	344	312	284	260	239	220	204	188	175	162	151
	1.5VLR20	5'-6	7'-1	7'-4	400	400	400	400	380	345	315	289	265	245	227	210	196	182	170
	1.5VLR19	6'-2	7'-10	8'-1	400	400	400	400	400	374	341	313	288	266	247	229	213	199	186
	1.5VLR18	6'-9	8'-4	8'-7	400	400	400	400	400	398	364	334	308	285	264	245	229	214	200
	1.5VLR16	6'-9	8'-6	8'-9	400	400	400	400	400	396	362	332	306	283	262	244	228	213	199

- Notes:
1. Minimum exterior bearing length required is 1.50 inches. Minimum interior bearing length required is 3.00 inches. If these minimum lengths are not provided, web crippling must be checked.
 2. Always contact Vulcraft when using loads in excess of 200 psf. Such loads often result from concentrated, dynamic, or long term load cases for which reductions due to bond breakage, concrete creep, etc. should be evaluated.
 3. All fire rated assemblies are subject to an upper live load limit of 250 psf.
 4. 3/4 in. diameter welded shear stud utilized for calculations.
 5. Refer to AISC for further stud material and installation requirements.

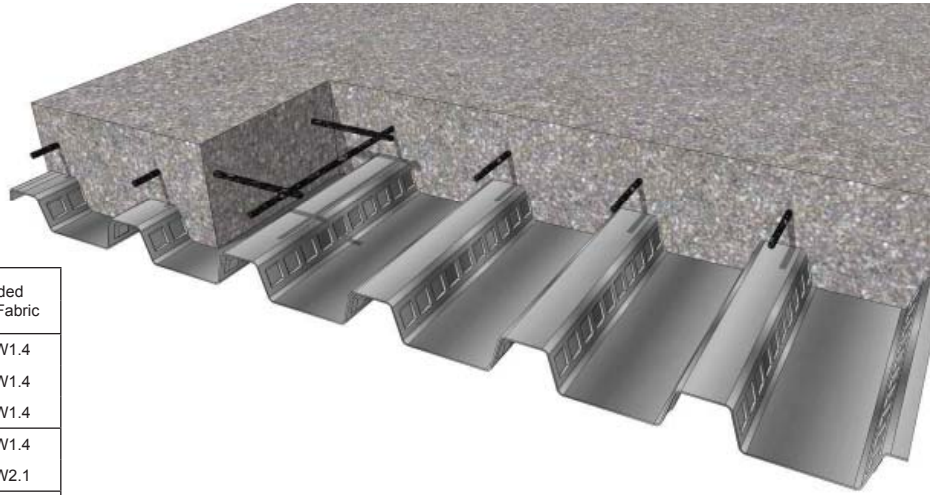

SLAB INFORMATION

Total Slab Depth, in.	Theoretical Concrete Volume		Recommended Welded Wire Fabric
	Yd ³ / 100 ft ²	ft ³ / ft ²	
3 1/2	0.92	2.47	6x6 - W1.4xW1.4
4	1.07	0.289	6x6 - W1.4xW1.4
4 1/2	1.22	0.331	6x6 - W1.4xW1.4
4 3/4	1.3	0.352	6x6 - W1.4xW1.4
5	1.38	0.372	6x6 - W2.1xW2.1
5 1/2	1.53	0.414	6x6 - W2.1xW2.1
5 3/4	1.61	0.435	6x6 - W2.1xW2.1
6	1.69	0.456	6x6 - W2.1xW2.1

(N=14.15) LIGHTWEIGHT CONCRETE (110 PCF)

Total Slab Depth	Deck Type	SDI Max. Unshored Clear Span			Superimposed Live Load (PSF) Clear Span (ft.-in.)														
		1 Span	2 Span	3 Span	5'-0	5'-6	6'-0	6'-6	7'-0	7'-6	8'-0	8'-6	9'-0	9'-6	10'-0	10'-6	11'-0	11'-6	12'-0
4.00 (t=2.50) 34 PSF	1.5VLR22	6'-0	7'-11	8'-1	324	288	258	212	192	174	159	146	134	124	115	106	98	86	76
	1.5VLR20	7'-1	9'-1	9'-5	355	315	283	256	233	192	176	161	149	137	127	119	105	92	81
	1.5VLR19	8'-0	10'-0	10'-4	382	339	304	275	251	230	212	175	161	149	139	128	111	97	85
	1.5VLR18	8'-9	10'-8	11'-0	400	360	323	292	266	244	225	209	172	160	148	134	116	102	90
	1.5VLR16	8'-9	10'-10	11'-2	400	360	323	292	266	244	225	209	172	159	148	138	128	112	98
4.50 (t=3.00) 39 PSF	1.5VLR22	5'-9	7'-7	7'-9	372	330	272	244	220	200	183	167	154	142	132	122	114	106	99
	1.5VLR20	6'-9	8'-9	9'-0	400	361	324	293	243	221	202	185	171	158	146	136	127	118	111
	1.5VLR19	7'-8	9'-7	9'-11	400	388	348	315	287	264	219	201	185	171	159	148	138	129	120
	1.5VLR18	8'-4	10'-3	10'-7	400	400	369	334	305	279	258	214	198	183	170	158	148	138	126
	1.5VLR16	8'-4	10'-4	10'-9	400	400	369	334	304	279	257	213	197	182	169	158	147	138	129
4.75 (t=3.25) 41 PSF	1.5VLR22	5'-8	7'-6	7'-7	396	352	290	260	235	213	195	178	164	152	141	130	121	113	106
	1.5VLR20	6'-7	8'-7	8'-10	400	385	345	312	259	235	215	198	182	168	156	145	135	126	118
	1.5VLR19	7'-6	9'-5	9'-9	400	400	371	336	306	281	233	214	197	183	170	158	147	138	129
	1.5VLR18	8'-2	10'-0	10'-5	400	400	393	356	324	298	274	228	211	195	181	169	158	147	138
	1.5VLR16	8'-2	10'-2	10'-6	400	400	392	355	324	297	274	227	210	194	180	168	157	147	138
5.00 (t=3.50) 43 PSF	1.5VLR22	5'-6	7'-4	7'-6	400	374	308	276	250	227	207	190	175	161	149	139	129	120	112
	1.5VLR20	6'-6	8'-5	8'-8	400	400	367	332	275	250	229	210	193	179	166	154	144	134	126
	1.5VLR19	7'-4	9'-3	9'-6	400	400	394	356	325	271	248	227	210	194	180	168	157	146	137
	1.5VLR18	8'-0	9'-10	10'-2	400	400	400	378	344	316	291	242	224	207	192	179	167	157	147
	1.5VLR16	8'-0	10'-0	10'-4	400	400	400	377	343	315	291	241	223	206	192	178	167	156	146
5.75 (t=4.25) 50 PSF	1.5VLR22	5'-3	6'-11	7'-1	400	400	364	326	295	268	244	224	206	191	177	164	153	142	133
	1.5VLR20	6'-2	8'-0	8'-3	400	400	400	360	325	295	270	248	229	211	196	182	170	159	149
	1.5VLR19	6'-11	8'-9	9'-1	400	400	400	400	351	319	292	268	248	229	213	198	185	173	162
	1.5VLR18	7'-6	9'-4	9'-8	400	400	400	400	400	372	311	286	264	245	227	212	198	185	174
	1.5VLR16	7'-7	9'-6	9'-10	400	400	400	400	400	371	309	284	263	243	226	211	197	184	173

- Notes:
1. Minimum exterior bearing length required is 1.50 inches. Minimum interior bearing length required is 3.00 inches. If these minimum lengths are not provided, web crippling must be checked.
 2. Always contact Vulcraft when using loads in excess of 200 psf. Such loads often result from concentrated, dynamic, or long term load cases for which reductions due to bond breakage, concrete creep, etc. should be evaluated.
 3. All fire rated assemblies are subject to an upper live load limit of 250 psf.
 4. 3/4 in. diameter welded shear stud utilized for calculations.
 5. Refer to AISC for further stud material and installation requirements.

1.5VLR-NO STUDS

1.5 VLR Stud Spacing - 12in C-C

Maximum Sheet Length 42'-0"
Extra charge for lengths under 6'-0"

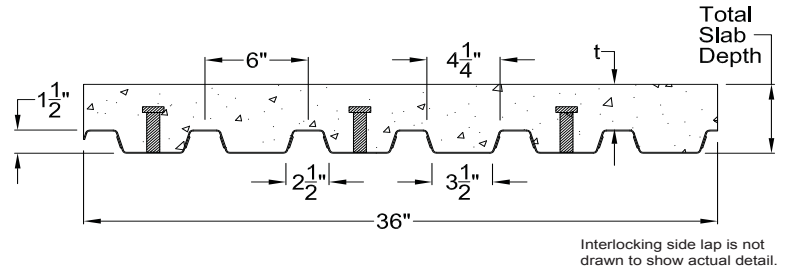

STEEL SECTION PROPERTIES

Deck type	Design thickness (in.)	Weight psf	Section Properties				A _s in ² /ft	ΦV _n lbs/ft	N (Normal Wt. Concrete) studs/ft	N (Lightweight Concrete) studs/ft	F _y ksi
			I _p in ⁴ /ft	S _p in ³ /ft	I _n in ⁴ /ft	S _n in ³ /ft					
1.5VLR22	0.0295	1.78	0.177	0.179	0.143	0.169	0.479	3992	0.422	0.519	50
1.5VLR20	0.0358	2.14	0.222	0.231	0.186	0.224	0.583	4820	0.512	0.630	50
1.5VLR19	0.0418	2.49	0.260	0.282	0.230	0.271	0.682	5602	0.598	0.736	50
1.5VLR18	0.0474	2.82	0.295	0.324	0.272	0.311	0.776	6323	0.678	0.834	50
1.5VLR16	0.0598	3.54	0.373	0.411	0.373	0.404	0.983	6318	0.684	0.842	40

(N=9.35) NORMAL WEIGHT CONCRETE (145 PCF)

Total Slab Depth	Deck Type	SDI Max. Unshored Clear Span			A _s in ² /ft	ΦV _n lb/ft	Superimposed Live Load (PSF) - Shear Studs at 12 in. c/c Clear Span (ft.-in.)															
		1 Span	2 Span	3 Span			5'-0"	5'-6"	6'-0"	6'-6"	7'-0"	7'-6"	8'-0"	8'-6"	9'-0"	9'-6"	10'-0"	10'-6"	11'-0"	11'-6"	12'-0"	
4.00 (t=2.50) 44 PSF	1.5VLR22	5'-6"	7'-3"	7'-5"	36.16	6735	400	400	400	400	400	400	376	326	285	250	221	196	171	149	130	114
	1.5VLR20	6'-5"	8'-4"	8'-8"	36.16	6735	400	400	400	400	400	400	400	391	343	290	246	211	182	159	139	122
	1.5VLR19	7'-3"	9'-2"	9'-6"	36.16	6735	400	400	400	400	400	400	400	400	364	306	261	223	193	168	147	129
	1.5VLR18	7'-11"	9'-9"	10'-1"	36.16	6735	400	400	400	400	400	400	400	400	382	321	273	234	202	176	154	136
	1.5VLR16	7'-11"	9'-11"	10'-3"	36.16	6735	400	400	400	400	400	400	400	400	400	364	321	284	253	222	193	169
4.50 (t=3.00) 50 PSF	1.5VLR22	5'-3"	6'-11"	7'-1"	41.83	7790	400	400	400	400	400	400	400	388	339	298	263	234	208	186	166	149
	1.5VLR20	6'-2"	8'-0"	8'-3"	41.83	7790	400	400	400	400	400	400	400	400	400	361	320	284	254	224	196	172
	1.5VLR19	6'-11"	8'-9"	9'-1"	41.83	7790	400	400	400	400	400	400	400	400	400	367	315	272	237	207	182	162
	1.5VLR18	7'-6"	9'-4"	9'-8"	41.83	7790	400	400	400	400	400	400	400	400	400	385	330	285	248	217	191	171
	1.5VLR16	7'-7"	9'-6"	9'-10"	41.83	7790	400	400	400	400	400	400	400	400	400	384	340	303	271	243	219	198
5.00 (t=3.50) 56 PSF	1.5VLR22	5'-0"	6'-8"	6'-10"	47.58	8421	400	400	400	400	400	400	400	400	393	346	306	271	242	216	193	173
	1.5VLR20	5'-10"	7'-8"	7'-11"	47.58	8860	400	400	400	400	400	400	400	400	400	400	372	331	296	266	239	215
	1.5VLR19	6'-7"	8'-5"	8'-8"	47.58	8860	400	400	400	400	400	400	400	400	400	400	386	346	311	280	247	227
	1.5VLR18	7'-2"	9'-0"	9'-3"	47.58	8860	400	400	400	400	400	400	400	400	400	400	400	387	336	294	259	239
	1.5VLR16	7'-3"	9'-1"	9'-5"	47.58	8860	400	400	400	400	400	400	400	400	400	400	397	354	316	284	256	231
5.50 (t=4.00) 62 PSF	1.5VLR22	4'-10"	6'-5"	6'-7"	52.70	8899	400	400	400	400	400	400	400	400	394	348	309	275	246	220	198	178
	1.5VLR20	5'-8"	7'-4"	7'-7"	52.70	9727	400	400	400	400	400	400	400	400	400	400	378	338	304	273	246	226
	1.5VLR19	6'-4"	8'-1"	8'-4"	52.70	9814	400	400	400	400	400	400	400	400	400	400	400	396	356	321	290	270
	1.5VLR18	6'-11"	8'-8"	8'-11"	52.70	9814	400	400	400	400	400	400	400	400	400	400	400	400	400	400	364	330
	1.5VLR16	6'-11"	8'-9"	9'-1"	52.70	9814	400	400	400	400	400	400	400	400	400	400	400	400	362	325	293	264
6.00 (t=4.50) 68 PSF	1.5VLR22	4'-8"	6'-2"	6'-4"	57.83	9376	400	400	400	400	400	400	400	400	400	390	347	309	276	248	222	202
	1.5VLR20	5'-6"	7'-1"	7'-4"	57.83	10204	400	400	400	400	400	400	400	400	400	400	400	400	380	341	307	277
	1.5VLR19	6'-2"	7'-10"	8'-1"	57.83	10768	400	400	400	400	400	400	400	400	400	400	400	400	400	400	362	328
	1.5VLR18	6'-9"	8'-4"	8'-7"	57.83	10768	400	400	400	400	400	400	400	400	400	400	400	400	400	400	400	373
	1.5VLR16	6'-9"	8'-6"	8'-9"	57.83	10768	400	400	400	400	400	400	400	400	400	400	400	400	400	400	366	330

- Notes:
1. Minimum exterior bearing length required is 1.50 inches. Minimum interior bearing length required is 3.00 inches. If these minimum lengths are not provided, web crippling must be checked.
 2. Always contact Vulcraft when using loads in excess of 200 psf. Such loads often result from concentrated, dynamic, or long term load cases for which reductions due to bond breakage, concrete creep, etc. should be evaluated.
 3. All fire rated assemblies are subject to an upper live load limit of 250 psf.
 4. 3/4 in. diameter welded shear stud utilized for calculations.
 5. Refer to AISC for further stud material and installation requirements.

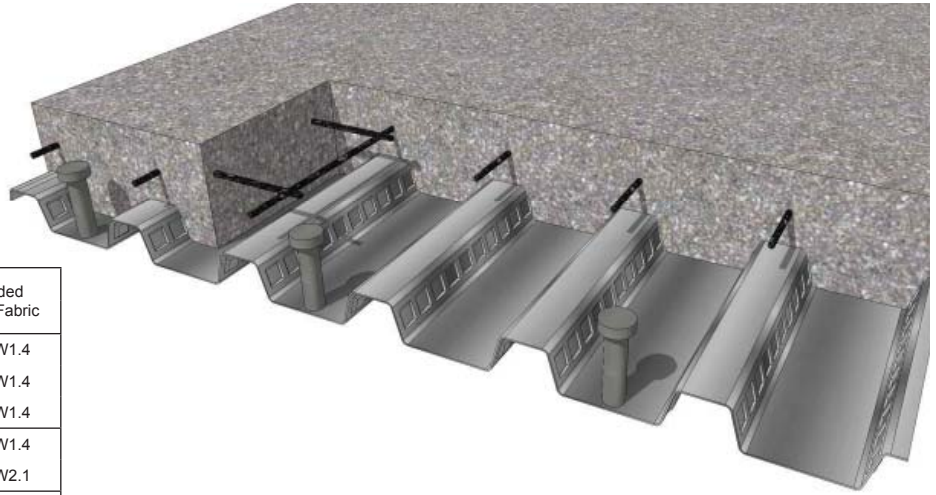

SLAB INFORMATION

Total Slab Depth, in.	Theoretical Concrete Volume		Recommended Welded Wire Fabric
	Yd ³ / 100 ft ²	ft ³ / ft ²	
3 1/2	0.92	2.47	6x6 - W1.4xW1.4
4	1.07	0.289	6x6 - W1.4xW1.4
4 1/2	1.22	0.331	6x6 - W1.4xW1.4
4 3/4	1.3	0.352	6x6 - W1.4xW1.4
5	1.38	0.372	6x6 - W2.1xW2.1
5 1/2	1.53	0.414	6x6 - W2.1xW2.1
5 3/4	1.61	0.435	6x6 - W2.1xW2.1
6	1.69	0.456	6x6 - W2.1xW2.1

(N=14.15) LIGHTWEIGHT CONCRETE (110 PCF)

Total Slab Depth	Deck Type	SDI Max. Unshored Clear Span			A _c in ² /ft	ΦV _{nt} lb/ft	Superimposed Live Load (PSF) - Shear Studs at 12 in. c/c															
		1 Span	2 Span	3 Span			Clear Span (ft.-in.)															
		5'-0"	5'-6"	6'-0"			6'-6"	7'-0"	7'-6"	8'-0"	8'-6"	9'-0"	9'-6"	10'-0"	10'-6"	11'-0"	11'-6"	12'-0"				
4.00 (t=2.50) 34 PSF	1.5VLR22	6'-0"	7'-11"	8'-1"	36.16	5051	400	400	400	400	381	310	255	213	179	152	131	113	98	86	76	
	1.5VLR20	7'-1"	9'-1"	9'-5"	36.16	5051	400	400	400	400	400	331	273	227	191	163	140	121	105	92	81	
	1.5VLR19	8'-0"	10'-0"	10'-4"	36.16	5051	400	400	400	400	400	350	288	240	202	172	148	128	111	97	85	
	1.5VLR18	8'-9"	10'-8"	11'-0"	36.16	5051	400	400	400	400	400	367	302	252	212	181	155	134	116	102	90	
	1.5VLR16	8'-9"	10'-10"	11'-2"	36.16	5051	400	400	400	400	400	400	332	277	233	198	170	147	128	112	98	
4.50 (t=3.00) 39 PSF	1.5VLR22	5'-9"	7'-7"	7'-9"	41.83	5843	400	400	400	400	400	400	360	300	253	215	184	159	139	121	107	
	1.5VLR20	6'-9"	8'-9"	9'-0"	41.83	5843	400	400	400	400	400	400	384	321	270	230	197	170	148	129	114	
	1.5VLR19	7'-8"	9'-7"	9'-11"	41.83	5843	400	400	400	400	400	400	339	285	243	208	180	156	137	120		
	1.5VLR18	8'-4"	10'-3"	10'-7"	41.83	5843	400	400	400	400	400	400	355	299	254	218	188	164	143	126		
	1.5VLR16	8'-4"	10'-4"	10'-9"	41.83	5843	400	400	400	400	400	400	389	328	279	239	206	179	157	138		
4.75 (t=3.25) 41 PSF	1.5VLR22	5'-8"	7'-6"	7'-7"	44.76	6252	400	400	400	400	400	400	400	352	296	252	216	187	162	142	125	
	1.5VLR20	6'-7"	8'-7"	8'-10"	44.76	6252	400	400	400	400	400	400	400	375	316	269	230	199	173	152	133	
	1.5VLR19	7'-6"	9'-5"	9'-9"	44.76	6252	400	400	400	400	400	400	396	334	284	243	210	183	160	141		
	1.5VLR18	8'-2"	10'-0"	10'-5"	44.76	6252	400	400	400	400	400	400	400	350	297	255	220	192	168	148		
	1.5VLR16	8'-2"	10'-2"	10'-6"	44.76	6252	400	400	400	400	400	400	400	383	326	279	241	210	184	162		
5.00 (t=3.50) 43 PSF	1.5VLR22	5'-6"	7'-4"	7'-6"	47.58	6645	400	400	400	400	400	400	400	400	344	293	251	217	189	165	145	
	1.5VLR20	6'-6"	8'-5"	8'-8"	47.58	6645	400	400	400	400	400	400	400	400	367	312	268	231	201	176	155	
	1.5VLR19	7'-4"	9'-3"	9'-6"	47.58	6645	400	400	400	400	400	400	400	400	387	329	282	244	212	186	163	
	1.5VLR18	8'-0"	9'-10"	10'-2"	47.58	6645	400	400	400	400	400	400	400	400	345	296	256	222	195	171		
	1.5VLR16	8'-0"	10'-0"	10'-4"	47.58	6645	400	400	400	400	400	400	400	400	378	324	280	243	213	187		
5.75 (t=4.25) 50 PSF	1.5VLR22	5'-3"	6'-11"	7'-1"	55.26	7718	400	400	400	400	400	400	400	400	400	381	340	305	274	247	218	
	1.5VLR20	6'-2"	8'-0"	8'-3"	55.26	7718	400	400	400	400	400	400	400	400	400	400	400	347	302	264	232	
	1.5VLR19	6'-11"	8'-9"	9'-1"	55.26	7718	400	400	400	400	400	400	400	400	400	400	400	366	318	278	245	
	1.5VLR18	7'-6"	9'-4"	9'-8"	55.26	7718	400	400	400	400	400	400	400	400	400	400	400	400	383	333	291	256
	1.5VLR16	7'-7"	9'-6"	9'-10"	55.26	7718	400	400	400	400	400	400	400	400	400	400	400	396	357	318	280	

- Notes:
1. Minimum exterior bearing length required is 1.50 inches. Minimum interior bearing length required is 3.00 inches. If these minimum lengths are not provided, web crippling must be checked.
 2. Always contact Vulcraft when using loads in excess of 200 psf. Such loads often result from concentrated, dynamic, or long term load cases for which reductions due to bond breakage, concrete creep, etc. should be evaluated.
 3. All fire rated assemblies are subject to an upper live load limit of 250 psf.
 4. 3/4 in. diameter welded shear stud utilized for calculations.
 5. Refer to AISC for further stud material and installation requirements.

1.5VLR - 12in C-C

1.5 VLR Stud Spacing - 24in C-C

Maximum Sheet Length 42'-0"
Extra charge for lengths under 6'-0"

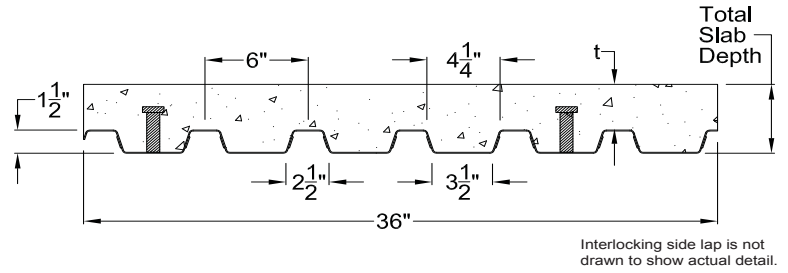

STEEL SECTION PROPERTIES

Deck type	Design thickness (in.)	Weight psf	Section Properties				A _s in ² /ft	ΦV _n lbs/ft	N (Normal Wt. Concrete) studs/ft	N (Lightweight Concrete) studs/ft	F _y ksi
			I _p in ⁴ /ft	S _p in ³ /ft	I _n in ⁴ /ft	S _n in ³ /ft					
1.5VLR22	0.0295	1.78	0.177	0.179	0.143	0.169	0.479	3992	0.422	0.519	50
1.5VLR20	0.0358	2.14	0.222	0.231	0.186	0.224	0.583	4820	0.512	0.630	50
1.5VLR19	0.0418	2.49	0.260	0.282	0.230	0.271	0.682	5602	0.598	0.736	50
1.5VLR18	0.0474	2.82	0.295	0.324	0.272	0.311	0.776	6323	0.678	0.834	50
1.5VLR16	0.0598	3.54	0.373	0.411	0.373	0.404	0.983	6318	0.684	0.842	40

(N=9.35) NORMAL WEIGHT CONCRETE (145 PCF)

Total Slab Depth	Deck Type	SDI Max. Unshored Clear Span			A _s in ² /ft	ΦV _n lb/ft	Superimposed Live Load (PSF) - Shear Studs at 24 in. c/c Clear Span (ft.-in.)														
		1 Span	2 Span	3 Span			5'-0	5'-6	6'-0	6'-6	7'-0	7'-6	8'-0	8'-6	9'-0	9'-6	10'-0	10'-6	11'-0	11'-6	12'-0
4.00 (t=2.50) 44 PSF	1.5VLR22	5'-6	7'-3	7'-5	36.16	6735	400	400	400	400	400	376	326	285	250	221	196	171	149	130	114
	1.5VLR20	6'-5	8'-4	8'-8	36.16	6735	400	399	398	397	396	396	386	339	290	246	211	182	159	139	122
	1.5VLR19	7'-3	9'-2	9'-6	36.16	6735	400	397	391	385	381	372	369	361	306	261	223	193	168	147	129
	1.5VLR18	7'-11	9'-9	10'-1	36.16	6735	400	400	391	382	374	367	354	349	321	273	234	202	176	154	136
4.50 (t=3.00) 50 PSF	1.5VLR16	7'-11	9'-11	10'-3	36.16	6735	400	400	391	381	373	367	353	322	286	255	229	206	186	169	149
	1.5VLR22	5'-3	6'-11	7'-1	41.83	7790	400	400	400	400	400	400	388	339	298	263	234	208	186	166	149
	1.5VLR20	6'-2	8'-0	8'-3	41.83	7790	400	400	399	398	397	396	396	395	357	316	282	252	224	196	172
	1.5VLR19	6'-11	8'-9	9'-1	41.83	7790	400	400	399	393	382	378	374	371	368	341	305	272	237	207	182
5.00 (t=3.50) 56 PSF	1.5VLR18	7'-6	9'-4	9'-8	41.83	7790	400	400	400	394	385	378	363	357	352	348	323	285	248	217	191
	1.5VLR16	7'-7	9'-6	9'-10	41.83	7790	400	400	400	394	385	377	362	356	339	303	272	245	221	201	182
	1.5VLR22	5'-0	6'-8	6'-10	47.58	8421	400	400	400	400	400	400	400	393	346	306	271	242	216	193	173
	1.5VLR20	5'-10	7'-8	7'-11	47.58	8860	400	400	400	399	398	397	397	396	396	368	328	293	263	237	213
5.50 (t=4.00) 62 PSF	1.5VLR19	6'-7	8'-5	8'-8	47.58	8860	400	400	400	400	389	384	379	376	372	370	355	319	288	261	236
	1.5VLR18	7'-2	9'-0	9'-3	47.58	8860	400	400	400	400	397	379	372	366	360	355	351	339	307	279	254
	1.5VLR16	7'-3	9'-1	9'-5	47.58	8860	400	400	400	400	397	378	371	364	359	351	315	284	257	233	212
	1.5VLR22	4'-10	6'-5	6'-7	52.70	9814	400	400	400	400	400	400	400	400	394	348	309	275	246	220	198
6.00 (t=4.50) 68 PSF	1.5VLR20	5'-8	7'-4	7'-7	52.70	9727	400	400	400	400	399	398	397	397	396	396	374	335	301	271	244
	1.5VLR19	6'-4	8'-1	8'-4	52.70	9814	400	400	400	400	395	390	385	381	377	374	371	365	329	298	270
	1.5VLR18	6'-11	8'-8	8'-11	52.70	9814	400	400	400	400	399	389	381	374	368	362	357	353	349	319	291
	1.5VLR16	6'-11	8'-9	9'-1	52.70	9814	400	400	400	400	398	389	380	373	367	361	356	323	293	265	242
6.00 (t=4.50) 68 PSF	1.5VLR22	4'-8	6'-2	6'-4	57.83	9376	400	400	400	400	400	400	400	400	400	390	347	309	276	248	222
	1.5VLR20	5'-6	7'-1	7'-4	57.83	10204	400	400	400	400	400	399	398	397	397	396	396	376	338	304	275
	1.5VLR19	6'-2	7'-10	8'-1	57.83	10768	400	400	400	400	400	396	390	386	382	378	375	372	369	335	304
	1.5VLR18	6'-9	8'-4	8'-7	57.83	10768	400	400	400	400	400	399	390	383	376	370	364	359	355	351	328
1.5VLR16	6'-9	8'-6	8'-9	57.83	10768	400	400	400	400	400	399	390	382	375	368	363	358	328	298	271	

- Notes:
1. Minimum exterior bearing length required is 1.50 inches. Minimum interior bearing length required is 3.00 inches. If these minimum lengths are not provided, web crippling must be checked.
 2. Always contact Vulcraft when using loads in excess of 200 psf. Such loads often result from concentrated, dynamic, or long term load cases for which reductions due to bond breakage, concrete creep, etc. should be evaluated.
 3. All fire rated assemblies are subject to an upper live load limit of 250 psf.
 4. 3/4 in. diameter welded shear stud utilized for calculations.
 5. Refer to AISC for further stud material and installation requirements.

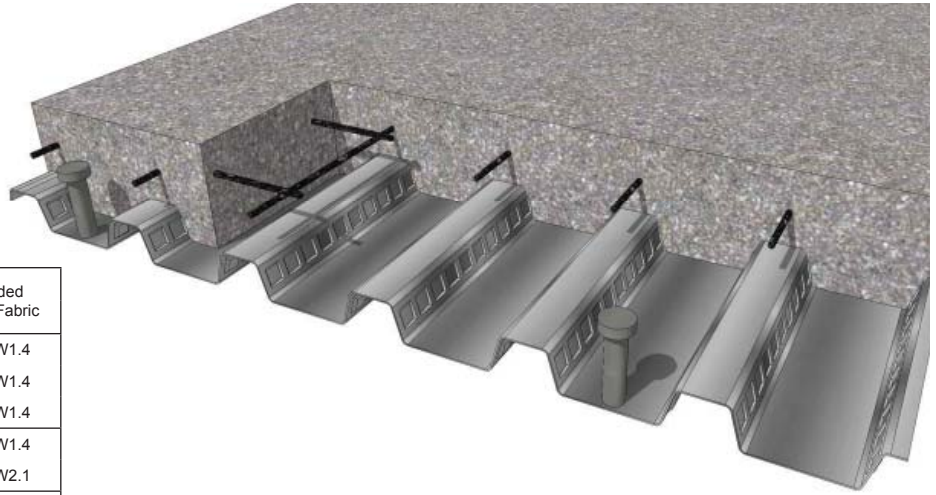

SLAB INFORMATION

Total Slab Depth, in.	Theoretical Concrete Volume		Recommended Welded Wire Fabric
	Yd ³ / 100 ft ²	ft ³ / ft ²	
3 1/2	0.92	2.47	6x6 - W1.4xW1.4
4	1.07	0.289	6x6 - W1.4xW1.4
4 1/2	1.22	0.331	6x6 - W1.4xW1.4
4 3/4	1.3	0.352	6x6 - W1.4xW1.4
5	1.38	0.372	6x6 - W2.1xW2.1
5 1/2	1.53	0.414	6x6 - W2.1xW2.1
5 3/4	1.61	0.435	6x6 - W2.1xW2.1
6	1.69	0.456	6x6 - W2.1xW2.1

(N=14.15) LIGHTWEIGHT CONCRETE (110 PCF)

Total Slab Depth	Deck Type	SDI Max. Unshored Clear Span			A _c in ² /ft	ΦV _{nt} lb/ft	Superimposed Live Load (PSF) - Shear Studs at 24 in. c/c														
		1 Span	2 Span	3 Span			Clear Span (ft.-in.)														
		5'-0"	5'-6"	6'-0"			6'-6"	7'-0"	7'-6"	8'-0"	8'-6"	9'-0"	9'-6"	10'-0"	10'-6"	11'-0"	11'-6"	12'-0"			
4.00 (t=2.50) 34 PSF	1.5VLR22	6'-0"	7'-11"	8'-1"	36.16	5051	397	396	395	393	381	310	255	213	179	152	131	113	98	86	76
	1.5VLR20	7'-1"	9'-1"	9'-5"	36.16	5051	391	382	376	370	366	331	273	227	191	163	140	121	105	92	81
	1.5VLR19	8'-0"	10'-0"	10'-4"	36.16	5051	394	380	369	360	352	346	288	240	202	172	148	128	111	97	85
	1.5VLR18	8'-9"	10'-8"	11'-0"	36.16	5051	400	384	369	357	346	338	302	252	212	181	155	134	116	102	90
	1.5VLR16	8'-9"	10'-10"	11'-2"	36.16	5051	400	384	369	356	346	337	329	277	233	198	170	147	128	112	98
4.50 (t=3.00) 39 PSF	1.5VLR22	5'-9"	7'-7"	7'-9"	41.83	5843	399	397	395	394	393	393	360	300	253	215	184	159	139	121	107
	1.5VLR20	6'-9"	8'-9"	9'-0"	41.83	5843	400	392	384	378	368	363	359	321	270	230	197	170	148	129	114
	1.5VLR19	7'-8"	9'-7"	9'-11"	41.83	5843	400	396	383	373	364	356	342	336	285	243	208	180	156	137	120
	1.5VLR18	8'-4"	10'-3"	10'-7"	41.83	5843	400	400	388	374	362	352	343	326	299	254	218	188	164	143	126
	1.5VLR16	8'-4"	10'-4"	10'-9"	41.83	5843	400	400	387	373	361	351	342	324	313	279	239	206	179	157	138
4.75 (t=3.25) 41 PSF	1.5VLR22	5'-8"	7'-6"	7'-7"	44.76	6252	400	398	396	395	394	393	392	352	296	252	216	187	162	142	125
	1.5VLR20	6'-7"	8'-7"	8'-10"	44.76	6252	400	397	389	382	371	366	362	358	316	269	230	199	173	152	133
	1.5VLR19	7'-6"	9'-5"	9'-9"	44.76	6252	400	400	391	379	370	362	346	340	334	284	243	210	183	160	141
	1.5VLR18	8'-2"	10'-0"	10'-5"	44.76	6252	400	400	397	382	370	359	350	331	324	297	255	220	192	168	148
	1.5VLR16	8'-2"	10'-2"	10'-6"	44.76	6252	400	400	397	382	369	358	349	330	323	303	274	241	210	184	162
5.00 (t=3.50) 43 PSF	1.5VLR22	5'-6"	7'-4"	7'-6"	47.58	6645	400	399	397	395	394	394	393	392	344	293	251	217	189	165	145
	1.5VLR20	6'-6"	8'-5"	8'-8"	47.58	6645	400	400	393	386	374	369	365	361	357	312	268	231	201	176	155
	1.5VLR19	7'-4"	9'-3"	9'-6"	47.58	6645	400	400	398	386	376	359	351	345	339	329	282	244	212	186	163
	1.5VLR18	8'-0"	9'-10"	10'-2"	47.58	6645	400	400	400	391	378	366	356	337	329	323	296	256	222	195	171
	1.5VLR16	8'-0"	10'-0"	10'-4"	47.58	6645	400	400	400	391	377	365	356	336	328	321	294	266	243	213	187
5.75 (t=4.25) 50 PSF	1.5VLR22	5'-3"	6'-11"	7'-1"	55.26	7718	400	400	399	397	396	395	394	394	393	374	334	300	269	243	218
	1.5VLR20	6'-2"	8'-0"	8'-3"	55.26	7718	400	400	400	392	385	378	373	369	365	361	358	333	301	264	232
	1.5VLR19	6'-11"	8'-9"	9'-1"	55.26	7718	400	400	400	400	384	374	365	358	351	345	340	335	318	278	245
	1.5VLR18	7'-6"	9'-4"	9'-8"	55.26	7718	400	400	400	400	400	389	364	354	346	338	331	325	319	291	256
	1.5VLR16	7'-7"	9'-6"	9'-10"	55.26	7718	400	400	400	400	400	388	363	353	344	336	329	321	292	267	244

- Notes:
1. Minimum exterior bearing length required is 1.50 inches. Minimum interior bearing length required is 3.00 inches. If these minimum lengths are not provided, web crippling must be checked.
 2. Always contact Vulcraft when using loads in excess of 200 psf. Such loads often result from concentrated, dynamic, or long term load cases for which reductions due to bond breakage, concrete creep, etc. should be evaluated.
 3. All fire rated assemblies are subject to an upper live load limit of 250 psf.
 4. 3/4 in. diameter welded shear stud utilized for calculations.
 5. Refer to AISC for further stud material and installation requirements.

1.5VLR - 24in C-C

1.5 VLR Stud Spacing - 36in C-C

Maximum Sheet Length 42'-0"
Extra charge for lengths under 6'-0"

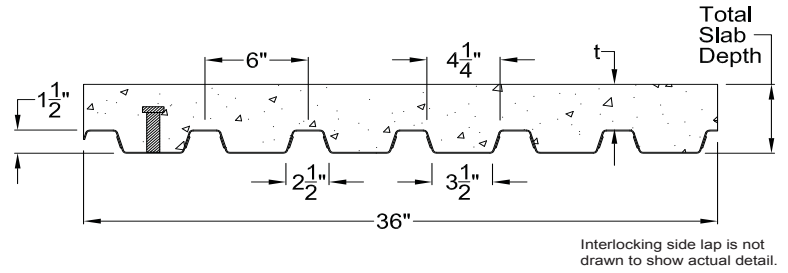

STEEL SECTION PROPERTIES

Deck type	Design thickness (in.)	Weight psf	Section Properties				A _s in ² /ft	ΦV _n lbs/ft	N (Normal Wt. Concrete) studs/ft	N (Lightweight Concrete) studs/ft	F _y ksi
			I _p in ⁴ /ft	S _p in ³ /ft	I _n in ⁴ /ft	S _n in ³ /ft					
1.5VLR22	0.0295	1.78	0.177	0.179	0.143	0.169	0.479	3992	0.422	0.519	50
1.5VLR20	0.0358	2.14	0.222	0.231	0.186	0.224	0.583	4820	0.512	0.630	50
1.5VLR19	0.0418	2.49	0.260	0.282	0.230	0.271	0.682	5602	0.598	0.736	50
1.5VLR18	0.0474	2.82	0.295	0.324	0.272	0.311	0.776	6323	0.678	0.834	50
1.5VLR16	0.0598	3.54	0.373	0.411	0.373	0.404	0.983	6318	0.684	0.842	40

(N=9.35) NORMAL WEIGHT CONCRETE (145 PCF)

Total Slab Depth	Deck Type	SDI Max. Unshored Clear Span			A _s in ² /ft	ΦV _n lb/ft	Superimposed Live Load (PSF) - Shear Studs at 36 in. c/c Clear Span (ft.-in.)														
		1 Span	2 Span	3 Span			5'-0	5'-6	6'-0	6'-6	7'-0	7'-6	8'-0	8'-6	9'-0	9'-6	10'-0	10'-6	11'-0	11'-6	12'-0
4.00 (t=2.50) 44 PSF	1.5VLR22	5'-6	7'-3	7'-5	36.16	6735	393	384	371	366	361	337	295	259	229	203	181	162	145	130	114
	1.5VLR20	6'-5	8'-4	8'-8	36.16	6735	400	385	372	352	343	335	323	285	254	227	204	182	159	139	122
	1.5VLR19	7'-3	9'-2	9'-6	36.16	6735	400	392	375	361	348	326	317	305	273	245	221	193	168	147	129
	1.5VLR18	7'-11	9'-9	10'-1	36.16	6735	400	400	382	364	350	337	312	302	287	259	234	202	176	154	136
	1.5VLR16	7'-11	9'-11	10'-3	36.16	6735	400	400	382	364	349	336	311	283	254	229	207	188	171	157	143
4.50 (t=3.00) 50 PSF	1.5VLR22	5'-3	6'-11	7'-1	41.83	7790	400	388	380	373	367	363	349	307	271	241	215	192	173	155	140
	1.5VLR20	6'-2	8'-0	8'-3	41.83	7790	400	400	388	365	355	346	338	332	301	269	241	217	197	178	162
	1.5VLR19	6'-11	8'-9	9'-1	41.83	7790	400	400	397	381	353	341	330	321	314	290	262	237	215	196	179
	1.5VLR18	7'-6	9'-4	9'-8	41.83	7790	400	400	400	389	372	357	328	317	308	300	278	252	230	210	191
	1.5VLR16	7'-7	9'-6	9'-10	41.83	7790	400	400	400	388	371	357	327	316	299	269	244	221	202	184	169
5.00 (t=3.50) 56 PSF	1.5VLR22	5'-0	6'-8	6'-10	47.58	8421	400	397	388	381	374	369	364	355	314	279	249	223	200	180	162
	1.5VLR20	5'-10	7'-8	7'-11	47.58	8860	400	400	393	379	367	357	349	341	335	311	279	252	228	207	188
	1.5VLR19	6'-7	8'-5	8'-8	47.58	8860	400	400	400	400	370	356	345	335	326	318	303	274	249	227	207
	1.5VLR18	7'-2	9'-0	9'-3	47.58	8860	400	400	400	400	394	360	346	333	323	313	305	292	266	243	223
	1.5VLR16	7'-3	9'-1	9'-5	47.58	8860	400	400	400	400	394	359	345	332	321	310	281	255	232	212	195
5.50 (t=4.00) 62 PSF	1.5VLR22	4'-10	6'-5	6'-7	52.70	8899	400	400	397	388	381	375	370	365	356	317	283	253	227	205	185
	1.5VLR20	5'-8	7'-4	7'-7	52.70	9727	400	400	400	393	380	369	359	351	344	337	318	286	259	235	214
	1.5VLR19	6'-4	8'-1	8'-4	52.70	9814	400	400	400	400	387	372	359	348	338	329	321	312	284	258	236
	1.5VLR18	6'-11	8'-8	8'-11	52.70	9814	400	400	400	400	398	379	363	350	338	327	318	309	301	277	254
	1.5VLR16	6'-11	8'-9	9'-1	52.70	9814	400	400	400	400	397	378	362	349	336	326	316	289	263	241	221
6.00 (t=4.50) 68 PSF	1.5VLR22	4'-8	6'-2	6'-4	57.83	9376	400	400	400	396	388	382	376	371	366	355	317	284	255	230	207
	1.5VLR20	5'-6	7'-1	7'-4	57.83	10204	400	400	400	400	393	381	370	361	353	346	340	321	291	264	240
	1.5VLR19	6'-2	7'-10	8'-1	57.83	10768	400	400	400	400	400	388	374	361	350	341	332	324	317	290	265
	1.5VLR18	6'-9	8'-4	8'-7	57.83	10768	400	400	400	400	400	399	382	366	353	341	331	321	313	305	285
	1.5VLR16	6'-9	8'-6	8'-9	57.83	10768	400	400	400	400	400	398	380	365	352	340	329	320	295	270	247

- Notes:
1. Minimum exterior bearing length required is 1.50 inches. Minimum interior bearing length required is 3.00 inches. If these minimum lengths are not provided, web crippling must be checked.
 2. Always contact Vulcraft when using loads in excess of 200 psf. Such loads often result from concentrated, dynamic, or long term load cases for which reductions due to bond breakage, concrete creep, etc. should be evaluated.
 3. All fire rated assemblies are subject to an upper live load limit of 250 psf.
 4. 3/4 in. diameter welded shear stud utilized for calculations.
 5. Refer to AISC for further stud material and installation requirements.

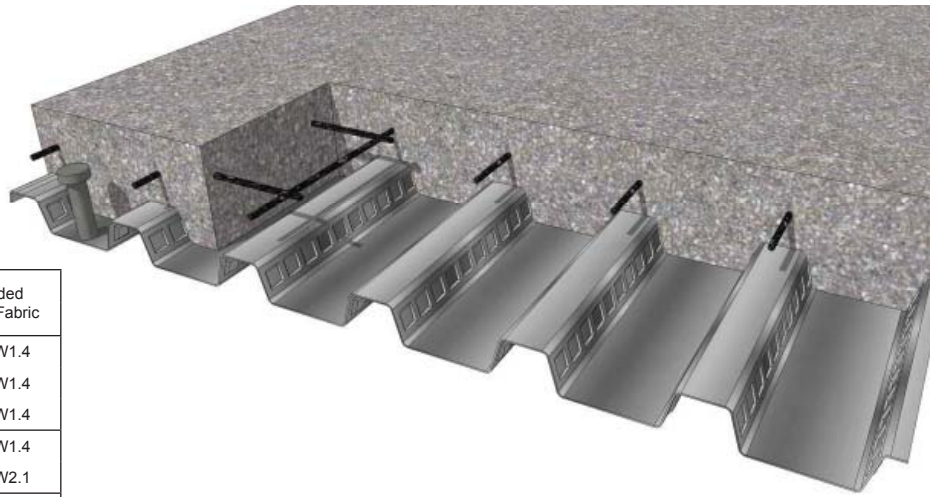

SLAB INFORMATION

Total Slab Depth, in.	Theoretical Concrete Volume		Recommended Welded Wire Fabric
	Yd ³ / 100 ft ²	ft ³ / ft ²	
3 1/2	0.92	2.47	6x6 - W1.4xW1.4
4	1.07	0.289	6x6 - W1.4xW1.4
4 1/2	1.22	0.331	6x6 - W1.4xW1.4
4 3/4	1.3	0.352	6x6 - W1.4xW1.4
5	1.38	0.372	6x6 - W2.1xW2.1
5 1/2	1.53	0.414	6x6 - W2.1xW2.1
5 3/4	1.61	0.435	6x6 - W2.1xW2.1
6	1.69	0.456	6x6 - W2.1xW2.1

(N=14.15) LIGHTWEIGHT CONCRETE (110 PCF)

Total Slab Depth	Deck Type	SDI Max. Unshored Clear Span			A _c in ² /ft	ΦV _{nt} lb/ft	Superimposed Live Load (PSF) - Shear Studs at 36 in. c/c														
		1 Span	2 Span	3 Span			Clear Span (ft.-in.)														
		5'-0"	5'-6"	6'-0"			6'-6"	7'-0"	7'-6"	8'-0"	8'-6"	9'-0"	9'-6"	10'-0"	10'-6"	11'-0"	11'-6"	12'-0"			
4.00 (t=2.50) 34 PSF	1.5VLR22	6'-0"	7'-11"	8'-1"	36.16	5051	373	360	349	333	325	309	255	213	179	152	131	113	98	86	76
	1.5VLR20	7'-1"	9'-1"	9'-5"	36.16	5051	379	360	345	332	321	302	273	227	191	163	140	121	105	92	81
	1.5VLR19	8'-0"	10'-0"	10'-4"	36.16	5051	390	367	348	332	318	307	288	240	202	172	148	128	111	97	85
	1.5VLR18	8'-9"	10'-8"	11'-0"	36.16	5051	400	376	354	335	320	306	295	252	212	181	155	134	116	102	90
	1.5VLR16	8'-9"	10'-10"	11'-2"	36.16	5051	400	376	353	335	319	306	295	273	233	198	170	147	128	112	98
4.50 (t=3.00) 39 PSF	1.5VLR22	5'-9"	7'-7"	7'-9"	41.83	5843	390	375	354	344	336	328	320	283	252	215	184	159	139	121	107
	1.5VLR20	6'-9"	8'-9"	9'-0"	41.83	5843	400	382	364	350	326	316	307	299	270	230	197	170	148	129	114
	1.5VLR19	7'-8"	9'-7"	9'-11"	41.83	5843	400	394	372	354	338	325	301	291	282	243	208	180	156	137	120
	1.5VLR18	8'-4"	10'-3"	10'-7"	41.83	5843	400	400	382	360	343	328	315	288	278	254	218	188	164	143	126
	1.5VLR16	8'-4"	10'-4"	10'-9"	41.83	5843	400	400	381	360	342	327	314	287	274	248	226	206	179	157	138
4.75 (t=3.25) 41 PSF	1.5VLR22	5'-8"	7'-6"	7'-7"	44.76	6252	399	383	361	350	341	333	326	305	272	243	216	187	162	142	125
	1.5VLR20	6'-7"	8'-7"	8'-10"	44.76	6252	400	393	374	359	334	323	313	305	297	267	230	199	173	152	133
	1.5VLR19	7'-6"	9'-5"	9'-9"	44.76	6252	400	400	384	365	349	335	309	298	289	281	243	210	183	160	141
	1.5VLR18	8'-2"	10'-0"	10'-5"	44.76	6252	400	400	396	373	355	338	325	297	286	277	255	220	192	168	148
	1.5VLR16	8'-2"	10'-2"	10'-6"	44.76	6252	400	400	395	373	354	338	324	296	285	267	243	222	203	184	162
5.00 (t=3.50) 43 PSF	1.5VLR22	5'-6"	7'-4"	7'-6"	47.58	6645	400	391	367	356	346	338	331	325	291	261	234	212	189	165	145
	1.5VLR20	6'-6"	8'-5"	8'-8"	47.58	6645	400	400	384	368	341	329	319	310	303	287	259	231	201	176	155
	1.5VLR19	7'-4"	9'-3"	9'-6"	47.58	6645	400	400	397	376	359	329	317	306	296	287	278	244	212	186	163
	1.5VLR18	8'-0"	9'-10"	10'-2"	47.58	6645	400	400	400	387	367	349	335	305	294	284	275	256	222	195	171
	1.5VLR16	8'-0"	10'-0"	10'-4"	47.58	6645	400	400	400	386	366	349	334	304	293	283	260	237	217	200	184
5.75 (t=4.25) 50 PSF	1.5VLR22	5'-3"	6'-11"	7'-1"	55.26	7718	400	400	387	374	362	353	344	337	331	313	282	254	231	210	191
	1.5VLR20	6'-2"	8'-0"	8'-3"	55.26	7718	400	400	400	381	365	351	339	328	319	311	304	283	257	235	215
	1.5VLR19	6'-11"	8'-9"	9'-1"	55.26	7718	400	400	400	400	373	356	341	328	317	307	298	290	278	255	234
	1.5VLR18	7'-6"	9'-4"	9'-8"	55.26	7718	400	400	400	400	400	383	347	332	318	307	296	287	279	271	250
	1.5VLR16	7'-7"	9'-6"	9'-10"	55.26	7718	400	400	400	400	400	382	345	330	317	305	295	284	260	239	221

1.5VLR - 36in C-C

- Notes:
1. Minimum exterior bearing length required is 1.50 inches. Minimum interior bearing length required is 3.00 inches. If these minimum lengths are not provided, web crippling must be checked.
 2. Always contact Vulcraft when using loads in excess of 200 psf. Such loads often result from concentrated, dynamic, or long term load cases for which reductions due to bond breakage, concrete creep, etc. should be evaluated.
 3. All fire rated assemblies are subject to an upper live load limit of 250 psf.
 4. 3/4 in. diameter welded shear stud utilized for calculations.
 5. Refer to AISC for further stud material and installation requirements.

2 VLI No Studs

Maximum Sheet Length 42'-0"
Extra charge for lengths under 6'-0"
ICBO Approved (No. 3415)

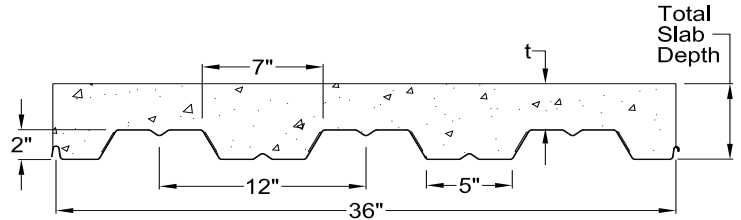

Interlocking side lap is not drawn to show actual detail.

STEEL SECTION PROPERTIES

Deck type	Design thickness (in.)	Weight psf	Section Properties				V _a lbs/ft	F _y ksi
			I _b in ⁴ /ft	S _b in ³ /ft	I _n in ⁴ /ft	S _n in ³ /ft		
2VLI22	0.0295	1.62	0.324	0.263	0.321	0.266	1832	50
2VLI20	0.0358	1.97	0.409	0.341	0.406	0.346	2698	50
2VLI19	0.0418	2.30	0.492	0.420	0.489	0.426	3190	50
2VLI18	0.0474	2.61	0.559	0.495	0.558	0.504	3608	50
2VLI16	0.0598	3.29	0.704	0.653	0.704	0.653	3618	40

(N=9.35) NORMAL WEIGHT CONCRETE (145 PCF)

Total Slab Depth	Deck Type	SDI Max. Unshored Clear Span			Superimposed Live Load (PSF) Clear Span (ft.-in.)															
		1 Span	2 Span	3 Span	5'-6"	6'-0"	6'-6"	7'-0"	7'-6"	8'-0"	8'-6"	9'-0"	9'-6"	10'-0"	10'-6"	11'-0"	11'-6"	12'-0"	12'-6"	
4.50 (t=2.50) 45 PSF	2VLI22	6'-11"	9'-0"	9'-4"	319	278	245	190	168	150	134	121	109	99	90	83	76	69	63	
	2VLI20	8'-2"	10'-3"	10'-7"	361	313	275	244	219	198	152	136	123	112	102	93	85	78	72	
	2VLI19	9'-2"	11'-5"	11'-9"	400	346	303	268	240	216	196	180	136	124	113	103	94	86	79	
	2VLI18	10'-2"	12'-4"	12'-4"	400	376	331	295	264	239	218	200	184	171	130	119	110	102	94	
	2VLI16	10'-5"	12'-6"	12'-11"	400	400	383	339	303	274	248	227	209	193	150	137	126	117	108	
5.00 (t=3.00) 51 PSF	2VLI22	6'-7"	8'-7"	8'-11"	364	317	279	217	192	171	153	138	125	113	103	94	86	79	72	
	2VLI20	7'-9"	9'-10"	10'-2"	400	356	313	278	249	193	173	156	141	128	116	106	97	89	82	
	2VLI19	8'-9"	10'-11"	11'-3"	400	394	345	306	273	247	224	172	156	141	128	117	107	99	91	
	2VLI18	9'-7"	11'-10"	11'-11"	400	400	377	336	301	273	249	228	210	162	148	136	126	116	107	
	2VLI16	9'-11"	12'-0"	12'-4"	400	400	400	386	346	312	283	259	238	187	171	157	144	133	123	
5.50 (t=3.50) 57 PSF	2VLI22	6'-4"	8'-0"	8'-6"	400	355	278	244	216	192	172	155	140	127	116	106	97	89	81	
	2VLI20	7'-5"	9'-5"	9'-9"	400	400	351	312	244	217	194	175	158	143	131	119	109	100	92	
	2VLI19	8'-4"	10'-5"	10'-9"	400	400	388	343	307	277	215	193	175	159	144	132	121	111	102	
	2VLI18	9'-2"	11'-4"	11'-7"	400	400	400	377	338	306	279	256	199	182	167	153	141	130	121	
	2VLI16	9'-5"	11'-6"	11'-10"	400	400	400	400	388	350	318	290	230	210	192	176	162	150	138	
6.00 (t=4.00) 63 PSF	2VLI22	6'-1"	7'-5"	8'-2"	400	394	308	270	239	213	191	172	156	141	129	118	108	99	90	
	2VLI20	7'-1"	9'-1"	9'-4"	400	400	390	346	271	241	215	194	175	159	145	132	121	111	102	
	2VLI19	8'-0"	10'-1"	10'-5"	400	400	400	381	340	307	239	215	194	176	160	146	134	123	113	
	2VLI18	8'-10"	10'-11"	11'-3"	400	400	400	400	375	339	309	243	221	202	185	170	157	145	134	
	2VLI16	9'-1"	11'-1"	11'-5"	400	400	400	400	400	388	352	322	255	233	213	195	180	166	154	
6.50 (t=4.50) 69 PSF	2VLI22	5'-11"	6'-11"	7'-11"	400	390	339	297	263	234	210	189	171	155	141	129	118	108	99	
	2VLI20	6'-11"	8'-9"	9'-0"	400	400	400	337	297	264	237	213	193	175	159	145	133	122	112	
	2VLI19	7'-10"	9'-8"	10'-0"	400	400	400	400	374	293	262	236	213	193	176	161	147	135	124	
	2VLI18	8'-7"	10'-6"	10'-11"	400	400	400	400	400	373	340	268	243	222	203	187	172	159	147	
	2VLI16	8'-10"	10'-8"	11'-0"	400	400	400	400	400	400	387	309	280	256	234	215	198	183	169	

- Notes:
1. Minimum exterior bearing length required is 2.00 inches. Minimum interior bearing length required is 4.00 inches. If these minimum lengths are not provided, web crippling must be checked.
 2. Always contact Vulcraft when using loads in excess of 200 psf. Such loads often result from concentrated, dynamic, or long term load cases for which reductions due to bond breakage, concrete creep, etc. should be evaluated.
 3. All fire rated assemblies are subject to an upper live load limit of 250 psf.
 4. 3/4 in. diameter welded shear stud utilized for calculations.
 5. Refer to AISC for further stud material and installation requirements.

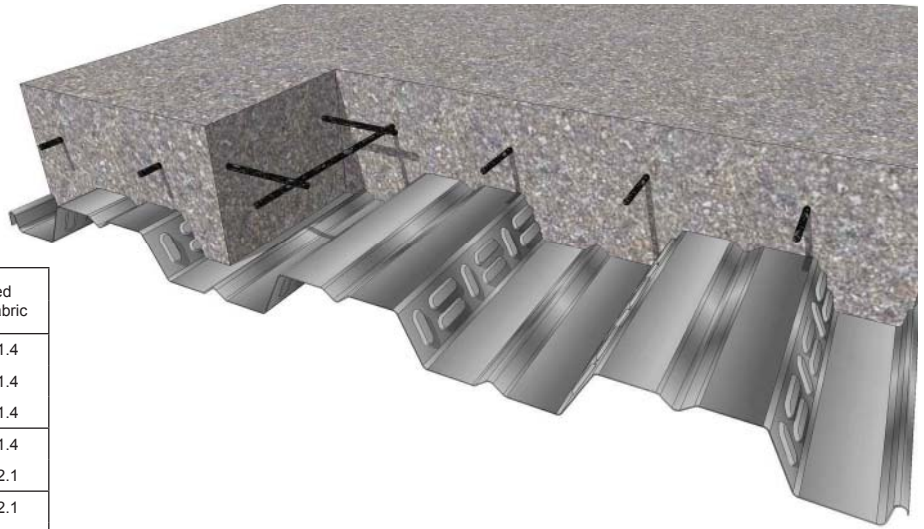

SLAB INFORMATION

Total Slab Depth, in.	Theoretical Concrete Volume		Recommended Welded Wire Fabric
	Yd ³ / 100 ft ²	ft ³ / ft ²	
4	0.93	0.250	6x6 - W1.4xW1.4
4 1/2	1.08	0.292	6x6 - W1.4xW1.4
5	1.23	0.333	6x6 - W1.4xW1.4
5 1/4	1.31	0.354	6x6 - W1.4xW1.4
5 1/2	1.39	0.375	6x6 - W2.1xW2.1
6	1.54	0.417	6x6 - W2.1xW2.1
6 1/4	1.62	0.438	6x6 - W2.1xW2.1
6 1/2	1.70	0.458	6x6 - W2.1xW2.1

(N=14.15) LIGHTWEIGHT CONCRETE (110 PCF)

Total Slab Depth	Deck Type	SDI Max. Unshored Clear Span			Superimposed Live Load (PSF) Clear Span (ft.-in.)														
		1 Span	2 Span	3 Span	6'-0	6'-6	7'-0	7'-6	8'-0	8'-6	9'-0	9'-6	10'-0	10'-6	11'-0	11'-6	12'-0	12'-6	13'-0
4.50 (t=2.50) 35 PSF	2VLI22	7'-8	9'-10	10'-2	276	243	216	194	155	139	126	114	104	96	88	81	75	69	64
	2VLI20	9'-0	11'-3	11'-7	312	273	243	217	196	178	163	128	117	107	98	90	83	77	72
	2VLI19	10'-3	12'-5	12'-9	346	302	268	239	215	195	178	164	151	118	108	100	92	85	79
	2VLI18	11'-2	13'-1	13'-1	376	331	294	264	238	217	199	183	170	158	147	116	107	100	93
5.00 (t=3.00) 39 PSF	2VLI16	11'-7	13'-8	13'-10	400	384	340	303	273	248	227	208	192	178	166	155	123	114	106
	2VLI22	7'-4	9'-5	9'-9	315	277	247	197	176	159	143	130	119	109	100	92	85	79	73
	2VLI20	8'-7	10'-9	11'-2	355	312	276	248	224	203	161	146	133	122	112	103	95	88	82
	2VLI19	9'-9	11'-11	12'-4	394	345	305	272	245	223	203	187	147	135	124	114	105	97	90
5.25 (t=3.25) 42 PSF	2VLI18	10'-9	12'-9	12'-9	400	377	335	300	272	247	227	209	193	180	143	132	122	114	106
	2VLI16	11'-0	13'-1	13'-5	400	400	387	346	311	283	258	237	219	203	189	151	140	130	121
	2VLI22	7'-2	9'-3	9'-7	334	294	262	209	187	168	152	138	126	116	106	98	90	84	78
	2VLI20	8'-5	10'-7	10'-11	377	331	293	263	237	190	171	155	142	130	119	110	101	94	87
5.50 (t=3.50) 44 PSF	2VLI19	9'-6	11'-8	12'-1	400	366	324	289	260	236	216	198	156	143	131	121	111	103	95
	2VLI18	10'-6	12'-7	12'-7	400	400	355	319	288	263	241	222	205	191	151	140	130	121	113
	2VLI16	10'-9	12'-10	13'-3	400	400	400	367	330	300	274	252	232	215	173	160	148	138	128
	2VLI22	7'-0	9'-1	9'-5	353	311	277	222	198	178	161	147	134	122	113	104	96	89	82
6.25 (t=4.25) 51 PSF	2VLI20	8'-3	10'-4	10'-9	399	350	310	278	251	201	181	165	150	137	126	116	107	99	92
	2VLI19	9'-4	11'-6	11'-10	400	387	342	306	275	250	228	182	165	151	139	128	118	109	101
	2VLI18	10'-3	12'-5	12'-5	400	400	376	337	305	278	254	234	217	174	160	148	138	128	119
	2VLI16	10'-6	12'-7	13'-0	400	400	400	388	350	317	290	266	246	228	184	170	157	146	136
6.25 (t=4.25) 51 PSF	2VLI22	6'-8	8'-7	8'-11	400	362	291	258	231	208	188	171	156	143	131	121	112	103	96
	2VLI20	7'-9	9'-10	10'-2	400	400	361	323	260	234	211	192	175	160	147	135	125	115	107
	2VLI19	8'-9	10'-11	11'-3	400	400	398	356	320	291	233	212	193	176	162	149	137	127	118
	2VLI18	9'-8	11'-10	11'-11	400	400	400	392	355	323	296	273	220	202	187	173	160	149	139
2VLI16	9'-11	12'-0	12'-5	400	400	400	400	400	369	337	310	253	232	214	198	183	170	158	

- Notes:
1. Minimum exterior bearing length required is 2.00 inches. Minimum interior bearing length required is 4.00 inches. If these minimum lengths are not provided, web crippling must be checked.
 2. Always contact Vulcraft when using loads in excess of 200 psf. Such loads often result from concentrated, dynamic, or long term load cases for which reductions due to bond breakage, concrete creep, etc. should be evaluated.
 3. All fire rated assemblies are subject to an upper live load limit of 250 psf.
 4. 3/4 in. diameter welded shear stud utilized for calculations.
 5. Refer to AISC for further stud material and installation requirements.

2VLI - NO STUDS

2 VLI Stud Spacing - 12in C-C

Maximum Sheet Length 42'-0"
Extra charge for lengths under 6'-0"
ICBO Approved (No. 3415)

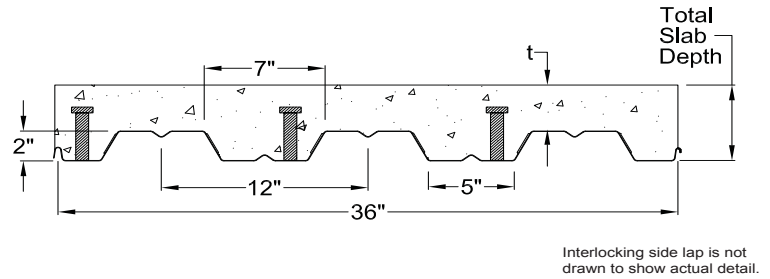

STEEL SECTION PROPERTIES

Deck type	Design thickness (in.)	Weight psf	Section Properties				A _s in ² /ft	ΦV _n lbs/ft	N (Normal Wt. Concrete) studs/ft	N (Lightweight Concrete) studs/ft	F _y ksi
			I _p in ⁴ /ft	S _p in ³ /ft	I _n in ⁴ /ft	S _n in ³ /ft					
2VLI22	0.0295	1.62	0.324	0.263	0.321	0.266	0.463	2495	0.564	0.694	50
2VLI20	0.0358	1.97	0.409	0.341	0.406	0.346	0.562	3677	0.685	0.843	50
2VLI19	0.0418	2.30	0.492	0.420	0.489	0.426	0.656	4352	0.800	0.984	50
2VLI18	0.0474	2.61	0.559	0.495	0.558	0.504	0.744	4925	0.907	1.116	50
2VLI16	0.0598	3.29	0.704	0.653	0.704	0.653	0.939	4948	0.915	1.126	40

(N=9.35) NORMAL WEIGHT CONCRETE (145 PCF)

Total Slab Depth	Deck Type	SDI Max. Unshored Clear Span			A _c in ² /ft	ΦV _n lb/ft	Superimposed Live Load (PSF) - Shear Studs at 12 in. c/c Clear Span (ft.-in.)																	
		1 Span	2 Span	3 Span			5'-6	6'-0	6'-6	7'-0	7'-6	8'-0	8'-6	9'-0	9'-6	10'-0	10'-6	11'-0	11'-6	12'-0	12'-6			
4.50 (t=2.50) 45 PSF	2VLI22	6'-11	9'-0	9'-3	32.33	5505	400	400	400	400	400	400	400	400	376	329	290	257	228	204	182	164	147	133
	2VLI20	8'-2	10'-3	10'-7	32.33	6021	400	400	400	400	400	400	400	400	400	396	349	310	276	247	217	190	167	148
	2VLI19	9'-2	11'-4	11'-9	32.33	6021	400	400	400	400	400	400	400	400	400	400	400	358	307	265	231	202	178	157
	2VLI18	10'-2	12'-4	12'-4	32.33	6021	400	400	400	400	400	400	400	400	400	400	400	377	323	279	243	213	187	166
	2VLI16	10'-5	12'-6	12'-11	32.33	6021	400	400	400	400	400	400	400	400	400	400	369	328	292	262	235	212	192	174
5.00 (t=3.00) 51 PSF	2VLI22	6'-7	8'-7	8'-10	37.14	5952	400	400	400	400	400	400	400	400	381	336	297	264	236	211	190	171	154	
	2VLI20	7'-9	9'-10	10'-2	37.14	6916	400	400	400	400	400	400	400	400	400	400	360	321	288	259	233	211	191	
	2VLI19	8'-9	10'-10	11'-3	37.14	6916	400	400	400	400	400	400	400	400	400	400	400	373	335	301	271	238	211	
	2VLI18	9'-7	11'-10	11'-11	37.14	6916	400	400	400	400	400	400	400	400	400	400	400	374	325	285	250	222		
	2VLI16	9'-11	11'-11	12'-4	37.14	6916	400	400	400	400	400	400	400	400	400	400	382	341	305	274	247	224	203	
5.50 (t=3.50) 57 PSF	2VLI22	6'-4	8'-0	8'-6	42.18	6422	400	400	400	400	400	400	400	400	382	338	301	269	241	216	194	175		
	2VLI20	7'-5	9'-5	9'-9	42.18	7605	400	400	400	400	400	400	400	400	400	400	367	328	295	266	240	218		
	2VLI19	8'-4	10'-5	10'-9	42.18	7856	400	400	400	400	400	400	400	400	400	400	400	383	345	311	282	256		
	2VLI18	9'-2	11'-4	11'-7	42.18	7856	400	400	400	400	400	400	400	400	400	400	400	389	352	320	289			
	2VLI16	9'-5	11'-6	11'-10	42.18	7856	400	400	400	400	400	400	400	400	400	400	389	348	313	283	256	232		
6.00 (t=4.00) 63 PSF	2VLI22	6'-1	7'-5	8'-2	47.48	6915	400	400	400	400	400	400	400	400	379	337	301	270	242	218	197			
	2VLI20	7'-1	9'-1	9'-4	47.48	8098	400	400	400	400	400	400	400	400	400	400	369	331	299	270	245			
	2VLI19	8'-0	10'-0	10'-4	47.48	8772	400	400	400	400	400	400	400	400	400	400	400	388	351	318	289			
	2VLI18	8'-10	10'-11	11'-3	47.48	8841	400	400	400	400	400	400	400	400	400	400	400	397	361	328				
	2VLI16	9'-1	11'-1	11'-5	47.48	8841	400	400	400	400	400	400	400	400	400	400	391	352	318	288	261			
6.50 (t=4.50) 69 PSF	2VLI22	5'-11	6'-11	7'-10	53.01	7430	400	400	400	400	400	400	400	400	373	333	299	269	242	218				
	2VLI20	6'-11	8'-9	9'-0	53.01	8613	400	400	400	400	400	400	400	400	400	400	368	332	300	272				
	2VLI19	7'-10	9'-8	10'-0	53.01	9288	400	400	400	400	400	400	400	400	400	400	400	390	354	321				
	2VLI18	8'-7	10'-6	10'-10	53.01	9861	400	400	400	400	400	400	400	400	400	400	400	400	400	366				
	2VLI16	8'-10	10'-8	11'-0	53.01	9872	400	400	400	400	400	400	400	400	400	400	400	391	353	320	290			

- Notes:
1. Minimum exterior bearing length required is 2.00 inches. Minimum interior bearing length required is 4.00 inches. If these minimum lengths are not provided, web crippling must be checked.
 2. Always contact Vulcraft when using loads in excess of 200 psf. Such loads often result from concentrated, dynamic, or long term load cases for which reductions due to bond breakage, concrete creep, etc. should be evaluated.
 3. All fire rated assemblies are subject to an upper live load limit of 250 psf.
 4. 3/4 in. diameter welded shear stud utilized for calculations.
 5. Refer to AISC for further stud material and installation requirements.

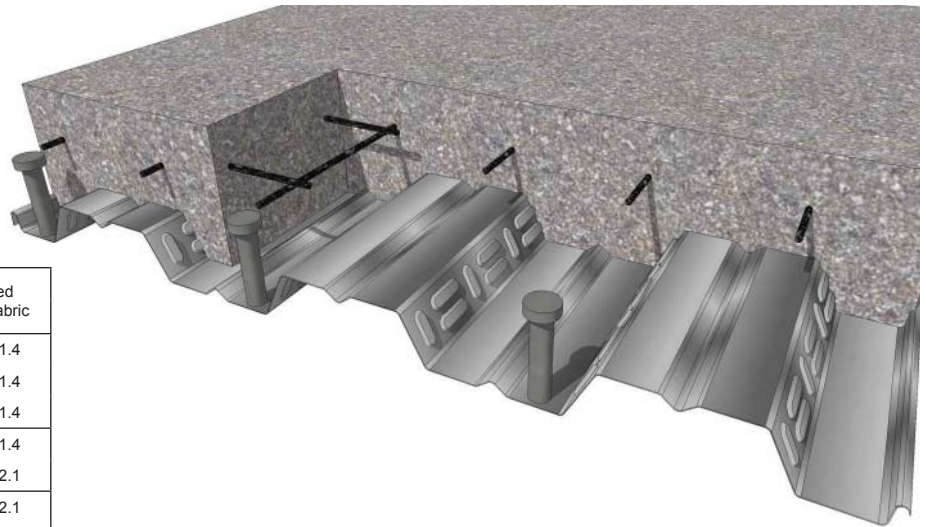

SLAB INFORMATION

Total Slab Depth, in.	Theoretical Concrete Volume		Recommended Welded Wire Fabric
	Yd ³ / 100 ft ²	ft ³ / ft ²	
4	0.93	0.250	6x6 - W1.4xW1.4
4 1/2	1.08	0.292	6x6 - W1.4xW1.4
5	1.23	0.333	6x6 - W1.4xW1.4
5 1/4	1.31	0.354	6x6 - W1.4xW1.4
5 1/2	1.39	0.375	6x6 - W2.1xW2.1
6	1.54	0.417	6x6 - W2.1xW2.1
6 1/4	1.62	0.438	6x6 - W2.1xW2.1
6 1/2	1.70	0.458	6x6 - W2.1xW2.1

(N=14.15) LIGHTWEIGHT CONCRETE (110 PCF)

Total Slab Depth	Deck Type	SDI Max. Unshored Clear Span			A _c in ² /ft	ΦV _m lb/ft	Superimposed Live Load (PSF) - Shear Studs at 12 in. c/c														
		1 Span	2 Span	3 Span			Clear Span (ft.-in.)														
4.50 (t=2.50) 45 PSF	2VLI22	7'-8"	9'-10"	10'-2"	32.33	4516	400	400	400	400	384	337	284	241	207	179	156	136	120	106	94
	2VLI20	9'-0"	11'-2"	11'-7"	32.33	4516	400	400	400	400	400	365	307	261	224	194	168	147	130	115	102
	2VLI19	10'-3"	12'-5"	12'-9"	32.33	4516	400	400	400	400	400	390	328	279	239	207	180	157	139	123	109
	2VLI18	11'-2"	13'-1"	13'-1"	32.33	4516	398	393	389	386	383	381	347	295	253	218	190	166	146	129	115
	2VLI16	11'-7"	13'-7"	13'-10"	32.33	4516	400	398	393	389	386	383	360	321	281	243	211	185	162	144	128
5.00 (t=3.00) 51 PSF	2VLI22	7'-4"	9'-5"	9'-9"	37.14	5088	400	400	400	400	400	390	345	306	274	240	208	182	161	142	126
	2VLI20	8'-7"	10'-9"	11'-1"	37.14	5187	400	400	400	400	400	400	350	300	259	225	197	174	154	136	
	2VLI19	9'-9"	11'-11"	12'-4"	37.14	5187	400	400	400	400	400	400	373	320	276	240	210	185	164	146	
	2VLI18	10'-9"	12'-9"	12'-9"	37.14	5187	400	398	393	390	387	384	382	380	338	292	254	222	195	173	154
	2VLI16	11'-0"	13'-1"	13'-5"	37.14	5187	400	400	399	394	390	387	384	374	335	302	273	245	217	192	170
5.25 (t=3.25) 42 PSF	2VLI22	7'-2"	9'-3"	9'-6"	39.63	5262	400	400	400	400	400	400	368	327	292	262	236	209	184	163	145
	2VLI20	8'-5"	10'-7"	10'-11"	39.63	5535	400	400	400	400	400	400	395	343	297	258	226	199	176	156	
	2VLI19	9'-6"	11'-8"	12'-1"	39.63	5535	400	400	400	400	400	400	400	366	316	275	241	212	188	167	
	2VLI18	10'-6"	12'-7"	12'-7"	39.63	5535	400	400	395	392	388	386	383	382	380	334	290	254	224	198	176
	2VLI16	10'-9"	12'-10"	13'-3"	39.63	5535	400	400	400	396	392	389	386	383	358	323	289	262	238	217	195
5.50 (t=3.50) 44 PSF	2VLI22	7'-0"	9'-1"	9'-4"	42.18	5441	400	400	400	400	400	400	392	348	311	279	251	227	205	186	165
	2VLI20	8'-3"	10'-4"	10'-8"	42.18	5892	400	400	400	400	400	400	400	400	377	338	294	257	226	200	178
	2VLI19	9'-4"	11'-6"	11'-10"	42.18	5892	400	400	400	400	400	400	400	400	360	313	274	241	213	190	
	2VLI18	10'-3"	12'-5"	12'-5"	42.18	5892	400	400	398	393	390	387	385	383	381	377	330	289	254	225	200
	2VLI16	10'-6"	12'-7"	13'-0"	42.18	5892	400	400	400	399	394	391	388	385	382	344	308	279	254	232	212
6.25 (t=4.25) 51 PSF	2VLI22	6'-7"	8'-7"	8'-11"	50.21	6001	400	400	400	400	400	400	400	400	367	329	297	268	243	220	200
	2VLI20	7'-9"	9'-10"	10'-2"	50.21	7013	400	400	400	400	400	400	400	400	400	400	362	328	298	271	247
	2VLI19	8'-9"	10'-11"	11'-3"	50.21	7013	400	400	400	400	400	400	400	400	400	400	400	383	344	305	271
	2VLI18	9'-8"	11'-10"	11'-11"	50.21	7013	400	400	400	399	395	392	389	387	381	380	378	376	363	321	285
	2VLI16	9'-11"	12'-0"	12'-5"	50.21	7013	400	400	400	400	400	397	393	390	384	381	365	331	301	275	251

- Notes:
1. Minimum exterior bearing length required is 2.00 inches. Minimum interior bearing length required is 4.00 inches. If these minimum lengths are not provided, web crippling must be checked.
 2. Always contact Vulcraft when using loads in excess of 200 psf. Such loads often result from concentrated, dynamic, or long term load cases for which reductions due to bond breakage, concrete creep, etc. should be evaluated.
 3. All fire rated assemblies are subject to an upper live load limit of 250 psf.
 4. 3/4 in. diameter welded shear stud utilized for calculations.
 5. Refer to AISC for further stud material and installation requirements.

2VLI - 12in C-C

2 VLI Stud Spacing - 24in C-C

Maximum Sheet Length 42'-0"
Extra charge for lengths under 6'-0"
ICBO Approved (No. 3415)

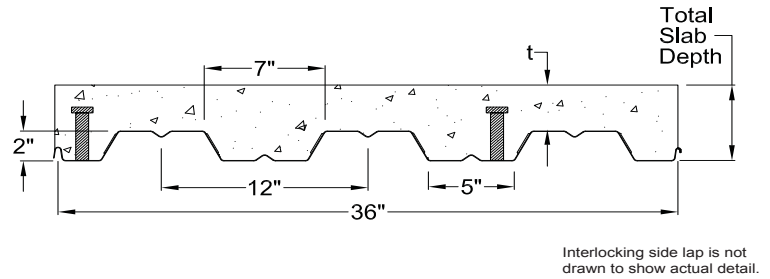

STEEL SECTION PROPERTIES

Deck type	Design thickness (in.)	Weight psf	Section Properties				A _s in ² /ft	ΦV _n lbs/ft	N (Normal Wt. Concrete) studs/ft	N (Lightweight Concrete) studs/ft	F _y ksi
			I _p in ⁴ /ft	S _p in ³ /ft	I _n in ⁴ /ft	S _n in ³ /ft					
2VLI22	0.0295	1.62	0.324	0.263	0.321	0.266	0.463	2495	0.564	0.694	50
2VLI20	0.0358	1.97	0.409	0.341	0.406	0.346	0.562	3677	0.685	0.843	50
2VLI19	0.0418	2.30	0.492	0.420	0.489	0.426	0.656	4352	0.800	0.984	50
2VLI18	0.0474	2.61	0.559	0.495	0.558	0.504	0.744	4925	0.907	1.116	50
2VLI16	0.0598	3.29	0.704	0.653	0.704	0.653	0.939	4948	0.915	1.126	40

(N=9.35) NORMAL WEIGHT CONCRETE (145 PCF)

Total Slab Depth	Deck Type	SDI Max. Unshored Clear Span			A _c in ² /ft	ΦV _n lb/ft	Superimposed Live Load (PSF) - Shear Studs at 24 in. c/c Clear Span (ft.-in.)															
		1 Span	2 Span	3 Span			5'-6	6'-0	6'-6	7'-0	7'-6	8'-0	8'-6	9'-0	9'-6	10'-0	10'-6	11'-0	11'-6	12'-0	12'-6	
4.50 (t=2.50) 45 PSF	2VLI22	6'-11	9'-0	9'-3	32.33	5505	391	386	382	376	374	350	307	271	240	213	191	171	154	138	125	
	2VLI20	8'-2	10'-3	10'-7	32.33	6021	389	376	366	358	351	345	330	292	260	232	208	187	169	153	139	
	2VLI19	9'-2	11'-4	11'-9	32.33	6021	400	380	364	351	340	331	324	317	275	246	221	200	181	164	149	
	2VLI18	10'-2	12'-4	12'-4	32.33	6021	400	389	369	353	339	328	318	310	303	274	236	213	194	177	161	
	2VLI16	10'-5	12'-6	12'-11	32.33	6021	400	400	392	372	356	343	331	305	274	247	211	191	173	158	144	
5.00 (t=3.00) 51 PSF	2VLI22	6'-7	8'-7	8'-10	37.14	5952	396	390	386	379	376	374	355	313	278	247	221	198	178	160	145	
	2VLI20	7'-9	9'-10	10'-2	37.14	6916	400	388	377	367	359	344	339	334	301	269	241	217	196	178	161	
	2VLI19	8'-9	10'-10	11'-3	37.14	6916	400	398	379	365	353	342	334	315	308	286	257	232	210	191	174	
	2VLI18	9'-7	11'-10	11'-11	37.14	6916	400	400	390	371	356	343	332	323	315	293	274	248	226	206	188	
	2VLI16	9'-11	11'-11	12'-4	37.14	6916	400	400	400	394	375	360	347	336	316	271	244	221	201	183	167	
5.50 (t=3.50) 57 PSF	2VLI22	6'-4	8'-0	8'-6	42.18	6422	400	395	386	382	379	376	374	356	316	281	251	225	202	182	165	
	2VLI20	7'-5	9'-5	9'-9	42.18	7605	400	400	387	376	358	351	344	339	335	306	275	248	224	203	184	
	2VLI19	8'-4	10'-5	10'-9	42.18	7856	400	400	395	379	365	354	331	323	316	310	293	265	240	218	198	
	2VLI18	9'-2	11'-4	11'-7	42.18	7856	400	400	400	390	372	358	346	335	310	302	295	283	258	235	215	
	2VLI16	9'-5	11'-6	11'-10	42.18	7856	400	400	400	400	394	377	363	350	323	307	277	251	228	208	190	
6.00 (t=4.00) 63 PSF	2VLI22	6'-1	7'-5	8'-2	47.48	6915	400	399	390	385	382	379	376	374	353	315	281	252	227	205	185	
	2VLI20	7'-1	9'-1	9'-4	47.48	8098	400	400	397	385	365	357	350	344	339	335	308	278	251	227	206	
	2VLI19	8'-0	10'-0	10'-4	47.48	8772	400	400	400	393	378	365	340	331	323	316	310	297	270	245	223	
	2VLI18	8'-10	10'-11	11'-3	47.48	8841	400	400	400	400	389	373	359	330	320	311	304	297	289	264	241	
	2VLI16	9'-1	11'-1	11'-5	47.48	8841	400	400	400	400	400	394	378	365	334	324	310	281	255	233	212	
6.50 (t=4.50) 69 PSF	2VLI22	5'-11	6'-11	7'-10	53.01	7430	400	399	393	388	384	381	378	376	374	348	312	280	251	227	205	
	2VLI20	6'-11	8'-9	9'-0	53.01	8613	400	400	400	383	372	363	356	350	344	339	335	308	278	252	229	
	2VLI19	7'-10	9'-8	10'-0	53.01	9288	400	400	400	400	390	360	348	339	330	323	316	310	299	272	247	
	2VLI18	8'-7	10'-6	10'-10	53.01	9861	400	400	400	400	400	388	373	341	330	320	312	304	298	292	268	
	2VLI16	8'-10	10'-8	11'-0	53.01	9872	400	400	400	400	400	400	394	359	346	334	325	311	283	257	235	

- Notes:
1. Minimum exterior bearing length required is 2.00 inches. Minimum interior bearing length required is 4.00 inches. If these minimum lengths are not provided, web crippling must be checked.
 2. Always contact Vulcraft when using loads in excess of 200 psf. Such loads often result from concentrated, dynamic, or long term load cases for which reductions due to bond breakage, concrete creep, etc. should be evaluated.
 3. All fire rated assemblies are subject to an upper live load limit of 250 psf.
 4. 3/4 in. diameter welded shear stud utilized for calculations.
 5. Refer to AISC for further stud material and installation requirements.

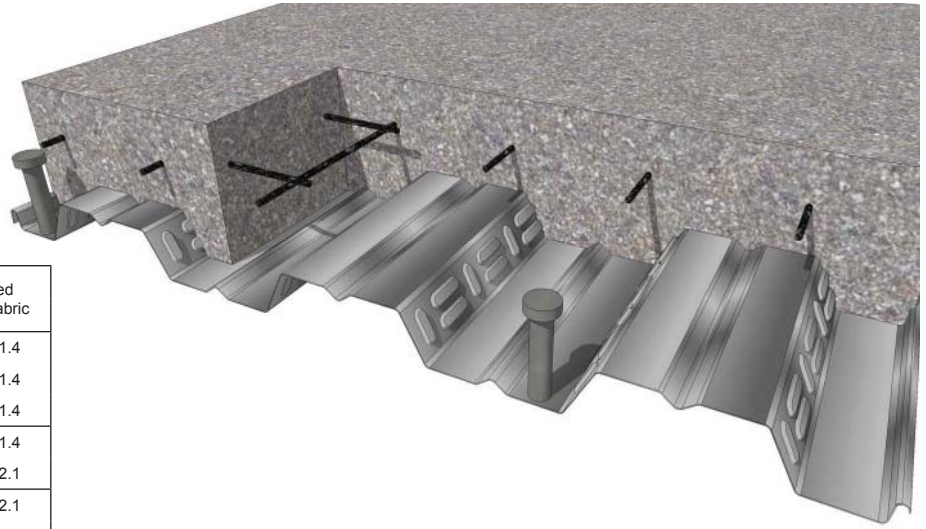

SLAB INFORMATION

Total Slab Depth, in.	Theoretical Concrete Volume		Recommended Welded Wire Fabric
	Yd ³ / 100 ft ²	ft ³ / ft ²	
4	0.93	0.250	6x6 - W1.4xW1.4
4 1/2	1.08	0.292	6x6 - W1.4xW1.4
5	1.23	0.333	6x6 - W1.4xW1.4
5 1/4	1.31	0.354	6x6 - W1.4xW1.4
5 1/2	1.39	0.375	6x6 - W2.1xW2.1
6	1.54	0.417	6x6 - W2.1xW2.1
6 1/4	1.62	0.438	6x6 - W2.1xW2.1
6 1/2	1.70	0.458	6x6 - W2.1xW2.1

(N=14.15) LIGHTWEIGHT CONCRETE (110 PCF)

Total Slab Depth	Deck Type	SDI Max. Unshored Clear Span			A _c in ² /ft	ΦV _{nt} lb/ft	Superimposed Live Load (PSF) - Shear Studs at 24 in. c/c														
		1 Span	2 Span	3 Span			Clear Span (ft.-in.)														
							6'-0	6'-6	7'-0	7'-6	8'-0	8'-6	9'-0	9'-6	10'-0	10'-6	11'-0	11'-6	12'-0	12'-6	13'-0
4.50 (t=2.50) 45 PSF	2VLI22	7'-8	9'-10	10'-2	32.33	4516	365	356	349	342	320	282	250	223	199	179	156	136	120	106	94
	2VLI20	9'-0	11'-2	11'-7	32.33	4516	364	349	336	326	317	310	278	241	216	194	168	147	130	115	102
	2VLI19	10'-3	12'-5	12'-9	32.33	4516	373	352	335	321	309	299	291	267	239	207	180	157	139	123	109
	2VLI18	11'-2	13'-1	13'-1	32.33	4516	387	362	342	325	311	299	289	280	253	218	190	166	146	129	115
	2VLI16	11'-7	13'-7	13'-10	32.33	4516	400	391	366	346	330	316	294	265	240	219	200	184	157	144	128
5.00 (t=3.00) 51 PSF	2VLI22	7'-4	9'-5	9'-9	37.14	5088	376	366	357	343	337	325	289	257	230	207	187	169	154	140	126
	2VLI20	8'-7	10'-9	11'-1	37.14	5187	382	364	350	338	328	320	303	279	250	226	205	186	169	154	136
	2VLI19	9'-9	11'-11	12'-4	37.14	5187	397	373	353	337	324	313	303	295	267	241	219	199	182	164	146
	2VLI18	10'-9	12'-9	12'-9	37.14	5187	400	387	364	345	329	316	304	295	286	272	235	215	195	173	154
	2VLI16	11'-0	13'-1	13'-5	37.14	5187	400	400	393	370	351	335	321	305	277	252	231	198	181	166	153
5.25 (t=3.25) 42 PSF	2VLI22	7'-2	9'-3	9'-6	39.63	5262	382	370	361	347	340	335	308	275	246	221	200	181	164	149	136
	2VLI20	8'-5	10'-7	10'-11	39.63	5535	391	372	357	344	334	314	307	298	268	241	219	199	181	165	151
	2VLI19	9'-6	11'-8	12'-1	39.63	5535	400	383	362	345	331	319	309	301	280	258	234	213	194	178	163
	2VLI18	10'-6	12'-7	12'-7	39.63	5535	400	400	375	355	338	324	312	302	293	285	251	229	210	193	176
	2VLI16	10'-9	12'-10	13'-3	39.63	5535	400	400	400	382	361	344	330	318	295	269	231	211	193	178	164
5.50 (t=3.50) 44 PSF	2VLI22	7'-0	9'-1	9'-4	42.18	5441	387	375	366	350	344	338	327	292	261	235	212	192	175	159	145
	2VLI20	8'-3	10'-4	10'-8	42.18	5892	399	380	364	350	339	319	311	304	285	257	232	211	193	176	161
	2VLI19	9'-4	11'-6	11'-10	42.18	5892	400	393	372	354	339	326	315	293	285	274	249	226	207	189	174
	2VLI18	10'-3	12'-5	12'-5	42.18	5892	400	400	387	365	348	333	320	309	299	275	268	244	224	206	190
	2VLI16	10'-6	12'-7	13'-0	42.18	5892	400	400	400	393	372	354	339	326	314	286	246	224	206	189	174
6.25 (t=4.25) 51 PSF	2VLI22	6'-7	8'-7	8'-11	50.21	6001	400	389	369	360	353	346	341	336	308	277	250	227	206	188	171
	2VLI20	7'-9	9'-10	10'-2	50.21	7013	400	400	384	369	343	332	323	315	308	302	274	249	227	208	190
	2VLI19	8'-9	10'-11	11'-3	50.21	7013	400	400	399	378	361	346	318	307	298	290	283	268	244	224	206
	2VLI18	9'-8	11'-10	11'-11	50.21	7013	400	400	400	396	375	358	343	330	301	291	282	275	265	243	224
	2VLI16	9'-11	12'-0	12'-5	50.21	7013	400	400	400	400	400	383	365	350	318	307	289	264	242	222	205

2VLI - 24in C-C

- Notes:
1. Minimum exterior bearing length required is 2.00 inches. Minimum interior bearing length required is 4.00 inches. If these minimum lengths are not provided, web crippling must be checked.
 2. Always contact Vulcraft when using loads in excess of 200 psf. Such loads often result from concentrated, dynamic, or long term load cases for which reductions due to bond breakage, concrete creep, etc. should be evaluated.
 3. All fire rated assemblies are subject to an upper live load limit of 250 psf.
 4. 3/4 in. diameter welded shear stud utilized for calculations.
 5. Refer to AISC for further stud material and installation requirements.

2 VLI Stud Spacing - 36in C-C

Maximum Sheet Length 42'-0"
Extra charge for lengths under 6'-0"
ICBO Approved (No. 3415)

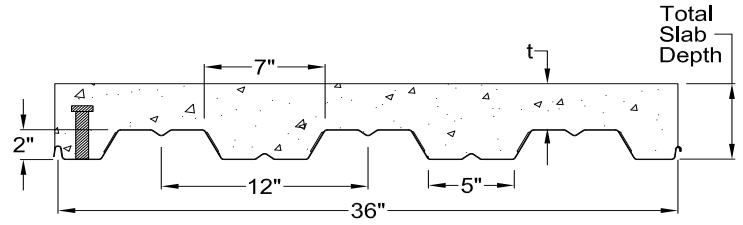

Interlocking side lap is not drawn to show actual detail.

STEEL SECTION PROPERTIES

Deck type	Design thickness (in.)	Weight psf	Section Properties				A _s in ² /ft	ΦV _n lbs/ft	N (Normal Wt. Concrete) studs/ft	N (Lightweight Concrete) studs/ft	F _y ksi
			I _p in ⁴ /ft	S _p in ³ /ft	I _n in ⁴ /ft	S _n in ³ /ft					
2VLI22	0.0295	1.62	0.324	0.263	0.321	0.266	0.463	2495	0.564	0.694	50
2VLI20	0.0358	1.97	0.409	0.341	0.406	0.346	0.562	3677	0.685	0.843	50
2VLI19	0.0418	2.30	0.492	0.420	0.489	0.426	0.656	4352	0.800	0.984	50
2VLI18	0.0474	2.61	0.559	0.495	0.558	0.504	0.744	4925	0.907	1.116	50
2VLI16	0.0598	3.29	0.704	0.653	0.704	0.653	0.939	4948	0.915	1.126	40

(N=9.35) NORMAL WEIGHT CONCRETE (145 PCF)

Total Slab Depth	Deck Type	SDI Max. Unshored Clear Span			A _c in ² /ft	ΦV _n lb/ft	Superimposed Live Load (PSF) - Shear Studs at 36 in. c/c Clear Span (ft.-in.)														
		1 Span	2 Span	3 Span			5'-6"	6'-0"	6'-6"	7'-0"	7'-6"	8'-0"	8'-6"	9'-0"	9'-6"	10'-0"	10'-6"	11'-0"	11'-6"	12'-0"	12'-6"
4.50 (t=2.50) 45 PSF	2VLI22	6'-11"	9'-0"	9'-3"	32.33	5505	367	350	336	314	305	283	249	221	196	175	157	141	128	115	104
	2VLI20	8'-2"	10'-3"	10'-7"	32.33	6021	380	355	336	320	307	296	270	240	214	192	173	156	141	128	116
	2VLI19	9'-2"	11'-4"	11'-9"	32.33	6021	400	368	343	323	307	293	281	271	229	205	185	167	152	138	126
	2VLI18	10'-2"	12'-4"	12'-4"	32.33	6021	400	385	356	333	314	298	285	274	264	240	200	182	166	152	139
	2VLI16	10'-5"	12'-6"	12'-11"	32.33	6021	400	400	389	361	339	320	304	279	252	229	190	173	158	144	132
5.00 (t=3.00) 51 PSF	2VLI22	6'-7"	8'-7"	8'-10"	37.14	5952	385	366	351	325	315	306	288	255	227	203	182	163	147	133	121
	2VLI20	7'-9"	9'-10"	10'-2"	37.14	6916	400	378	355	337	323	294	283	275	248	222	200	180	163	148	135
	2VLI19	8'-9"	10'-10"	11'-3"	37.14	6916	400	397	368	345	326	311	297	267	257	238	214	194	176	160	146
	2VLI18	9'-7"	11'-10"	11'-11"	37.14	6916	400	400	386	359	338	319	304	291	280	249	232	211	192	176	161
	2VLI16	9'-11"	11'-11"	12'-4"	37.14	6916	400	400	400	391	365	344	326	310	290	243	220	199	182	166	152
5.50 (t=3.50) 57 PSF	2VLI22	6'-4"	8'-0"	8'-6"	42.18	6422	400	382	350	336	324	315	307	289	257	230	206	185	167	151	137
	2VLI20	7'-5"	9'-5"	9'-9"	42.18	7605	400	400	375	355	320	306	294	284	276	252	227	205	185	168	153
	2VLI19	8'-4"	10'-5"	10'-9"	42.18	7856	400	400	393	367	346	328	292	280	269	259	244	221	200	182	166
	2VLI18	9'-2"	11'-4"	11'-7"	42.18	7856	400	400	400	385	361	341	323	309	273	262	252	240	219	200	183
	2VLI16	9'-5"	11'-6"	11'-10"	42.18	7856	400	400	400	400	392	368	348	330	292	275	249	226	206	188	173
6.00 (t=4.00) 63 PSF	2VLI22	6'-1"	7'-5"	8'-2"	47.48	6915	400	398	362	347	334	323	314	307	287	257	230	207	187	169	153
	2VLI20	7'-1"	9'-1"	9'-4"	47.48	8098	400	400	395	372	334	318	305	294	285	276	254	229	208	189	172
	2VLI19	8'-0"	10'-0"	10'-4"	47.48	8772	400	400	400	389	365	346	306	292	280	269	260	247	224	204	186
	2VLI18	8'-10"	10'-11"	11'-3"	47.48	8841	400	400	400	400	384	362	343	301	287	275	264	255	245	224	205
	2VLI16	9'-1"	11'-1"	11'-5"	47.48	8841	400	400	400	400	400	392	370	350	308	294	278	252	230	210	193
6.50 (t=4.50) 69 PSF	2VLI22	5'-11"	6'-11"	7'-10"	53.01	7430	400	396	375	358	344	332	322	314	306	284	255	229	207	187	170
	2VLI20	6'-11"	8'-9"	9'-0"	53.01	8613	400	400	400	368	347	330	316	304	294	284	276	254	230	209	190
	2VLI19	7'-10"	9'-8"	10'-0"	53.01	9288	400	400	400	400	385	338	320	304	291	280	269	261	248	226	206
	2VLI18	8'-7"	10'-6"	10'-10"	53.01	9861	400	400	400	400	400	383	362	316	301	287	276	265	256	248	228
	2VLI16	8'-10"	10'-8"	11'-0"	53.01	9872	400	400	400	400	400	400	392	342	324	308	294	279	254	233	213

- Notes:
1. Minimum exterior bearing length required is 2.00 inches. Minimum interior bearing length required is 4.00 inches. If these minimum lengths are not provided, web crippling must be checked.
 2. Always contact Vulcraft when using loads in excess of 200 psf. Such loads often result from concentrated, dynamic, or long term load cases for which reductions due to bond breakage, concrete creep, etc. should be evaluated.
 3. All fire rated assemblies are subject to an upper live load limit of 250 psf.
 4. 3/4 in. diameter welded shear stud utilized for calculations.
 5. Refer to AISC for further stud material and installation requirements.

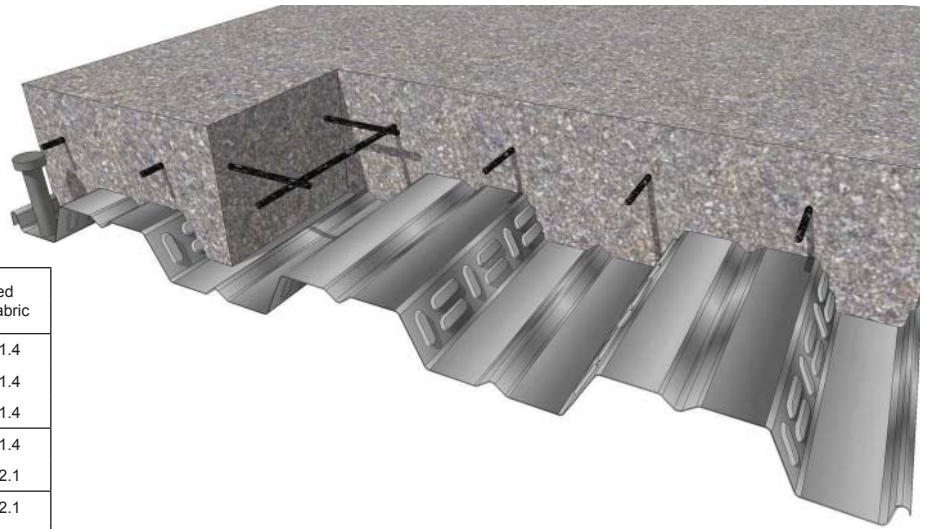

SLAB INFORMATION

Total Slab Depth, in.	Theoretical Concrete Volume		Recommended Welded Wire Fabric
	Yd ³ / 100 ft ²	ft ³ / ft ²	
4	0.93	0.250	6x6 - W1.4xW1.4
4 1/2	1.08	0.292	6x6 - W1.4xW1.4
5	1.23	0.333	6x6 - W1.4xW1.4
5 1/4	1.31	0.354	6x6 - W1.4xW1.4
5 1/2	1.39	0.375	6x6 - W2.1xW2.1
6	1.54	0.417	6x6 - W2.1xW2.1
6 1/4	1.62	0.438	6x6 - W2.1xW2.1
6 1/2	1.70	0.458	6x6 - W2.1xW2.1

(N=14.15) LIGHTWEIGHT CONCRETE (110 PCF)

Total Slab Depth	Deck Type	SDI Max. Unshored Clear Span			A _c in ² /ft	ΦV _{nt} lb/ft	Superimposed Live Load (PSF) - Shear Studs at 36 in. c/c														
		Clear Span					Clear Span (ft.-in.)														
		1 Span	2 Span	3 Span			6'-0	6'-6	7'-0	7'-6	8'-0	8'-6	9'-0	9'-6	10'-0	10'-6	11'-0	11'-6	12'-0	12'-6	13'-0
4.50 (t=2.50) 45 PSF	2VLI22	7'-8	9'-10	10'-2	32.33	4516	336	318	305	293	265	234	208	186	168	151	137	125	113	104	94
	2VLI20	9'-0	11'-2	11'-7	32.33	4516	347	324	305	290	277	266	240	203	183	166	150	137	125	115	102
	2VLI19	10'-3	12'-5	12'-9	32.33	4516	364	335	312	294	278	265	253	232	211	178	162	148	135	123	109
	2VLI18	11'-2	13'-1	13'-1	32.33	4516	383	352	326	304	287	272	259	248	228	209	190	162	146	129	115
	2VLI16	11'-7	13'-7	13'-10	32.33	4516	400	389	358	332	311	293	271	246	224	205	189	174	145	134	124
5.00 (t=3.00) 51 PSF	2VLI22	7'-4	9'-5	9'-9	37.14	5088	356	336	320	295	284	270	240	215	193	174	158	144	131	120	109
	2VLI20	8'-7	10'-9	11'-1	37.14	5187	373	347	325	308	293	281	256	235	211	191	174	158	145	133	122
	2VLI19	9'-9	11'-11	12'-4	37.14	5187	396	363	337	316	298	283	270	259	227	206	187	171	156	143	132
	2VLI18	10'-9	12'-9	12'-9	37.14	5187	400	384	354	330	310	293	279	266	255	241	204	187	172	158	146
	2VLI16	11'-0	13'-1	13'-5	37.14	5187	400	400	391	362	338	317	300	283	258	236	217	182	167	154	143
5.25 (t=3.25) 42 PSF	2VLI22	7'-2	9'-3	9'-6	39.63	5262	366	345	328	301	289	280	256	229	206	186	169	153	140	128	117
	2VLI20	8'-5	10'-7	10'-11	39.63	5535	386	358	336	317	302	273	262	250	226	204	185	169	154	141	130
	2VLI19	9'-6	11'-8	12'-1	39.63	5535	400	377	349	327	308	292	278	266	239	219	199	182	167	153	141
	2VLI18	10'-6	12'-7	12'-7	39.63	5535	400	400	369	343	322	304	288	275	263	253	218	200	184	169	156
	2VLI16	10'-9	12'-10	13'-3	39.63	5535	400	400	400	377	351	330	311	296	274	251	212	194	178	164	152
5.50 (t=3.50) 44 PSF	2VLI22	7'-0	9'-1	9'-4	42.18	5441	376	354	336	307	295	285	272	243	219	198	179	163	148	136	124
	2VLI20	8'-3	10'-4	10'-8	42.18	5892	399	370	346	326	310	280	268	258	240	217	197	180	164	150	138
	2VLI19	9'-4	11'-6	11'-10	42.18	5892	400	391	362	338	318	301	286	256	245	233	212	194	177	163	150
	2VLI18	10'-3	12'-5	12'-5	42.18	5892	400	400	383	356	333	314	298	284	272	241	232	212	195	180	166
	2VLI16	10'-6	12'-7	13'-0	42.18	5892	400	400	400	391	364	342	322	306	291	266	225	206	189	175	161
6.25 (t=4.25) 51 PSF	2VLI22	6'-7	8'-7	8'-11	50.21	6001	400	380	343	326	312	300	290	281	257	232	211	191	174	159	146
	2VLI20	7'-9	9'-10	10'-2	50.21	7013	400	400	376	354	316	299	286	274	264	255	232	211	193	177	163
	2VLI19	8'-9	10'-11	11'-3	50.21	7013	400	400	399	371	347	328	290	275	263	252	242	228	209	192	176
	2VLI18	9'-8	11'-10	11'-11	50.21	7013	400	400	400	395	368	346	327	311	274	261	250	241	230	212	196
	2VLI16	9'-11	12'-0	12'-5	50.21	7013	400	400	400	400	400	378	356	336	296	282	264	242	222	205	189

- Notes:
1. Minimum exterior bearing length required is 2.00 inches. Minimum interior bearing length required is 4.00 inches. If these minimum lengths are not provided, web crippling must be checked.
 2. Always contact Vulcraft when using loads in excess of 200 psf. Such loads often result from concentrated, dynamic, or long term load cases for which reductions due to bond breakage, concrete creep, etc. should be evaluated.
 3. All fire rated assemblies are subject to an upper live load limit of 250 psf.
 4. 3/4 in. diameter welded shear stud utilized for calculations.
 5. Refer to AISC for further stud material and installation requirements.

2VLI - 36in C-C

3 VLI No Studs

Maximum Sheet Length 42'-0"
Extra charge for lengths under 6'-0"
ICBO Approved (No. 3415)

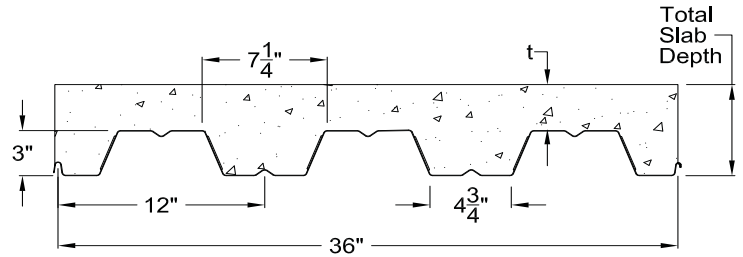

Interlocking side lap is not drawn to show actual detail.

STEEL SECTION PROPERTIES

Deck type	Design thickness (in.)	Weight psf	Section Properties				V _a lbs/ft	F _y ksi
			I _b in ⁴ /ft	S _p in ³ /ft	I _n in ⁴ /ft	S _n in ³ /ft		
3VLI22	0.0295	1.77	0.730	0.414	0.729	0.426	1407	50
3VLI20	0.0358	2.14	0.920	0.534	0.919	0.551	2485	50
3VLI19	0.0418	2.50	1.104	0.654	1.102	0.676	3390	50
3VLI18	0.0474	2.84	1.254	0.770	1.252	0.797	4361	50
3VLI16	0.0598	3.58	1.580	1.013	1.580	1.013	4901	40

(N=9.35) NORMAL WEIGHT CONCRETE (145 PCF)

Total Slab Depth	Deck Type	SDI Max. Unshored Clear Span			Superimposed Live Load (PSF) Clear Span (ft.-in.)														
		1 Span	2 Span	3 Span	7'-0	7'-6	8'-0	8'-6	9'-0	9'-6	10'-0	10'-6	11'-0	11'-6	12'-0	12'-6	13'-0	13'-6	14'-0
5.50 (t=2.50) 51 PSF	3VLI22	8'-9	9'-8	10'-11	247	222	201	184	137	124	113	103	94	87	80	73	67	62	57
	3VLI20	10'-1	12'-4	12'-9	275	247	223	203	186	171	159	116	106	97	89	82	76	70	65
	3VLI19	11'-4	13'-8	14'-2	302	270	244	222	203	186	172	160	149	107	98	90	83	77	71
	3VLI18	12'-5	14'-7	14'-7	330	298	271	248	229	212	197	184	173	162	153	112	105	98	92
	3VLI16	12'-9	14'-11	15'-5	373	335	304	277	255	235	218	203	190	178	168	159	117	109	102
6.00 (t=3.00) 57 PSF	3VLI22	8'-4	8'-10	10'-1	277	249	226	171	154	140	127	116	106	97	89	82	76	70	65
	3VLI20	9'-8	11'-10	12'-3	309	277	250	228	209	193	143	130	119	109	100	92	85	79	73
	3VLI19	10'-10	13'-2	13'-7	339	304	274	249	227	209	193	179	131	120	110	102	94	87	80
	3VLI18	11'-10	14'-2	14'-2	370	334	304	279	257	238	221	207	194	182	136	126	118	110	103
	3VLI16	12'-2	14'-4	14'-10	400	376	341	311	286	264	245	228	213	200	189	141	132	123	115
6.50 (t=3.50) 63 PSF	3VLI22	8'-0	8'-3	9'-4	307	277	251	190	171	155	141	129	118	108	99	91	84	78	72
	3VLI20	9'-3	11'-5	11'-9	343	307	278	253	232	174	158	144	132	121	111	103	95	87	81
	3VLI19	10'-4	12'-8	13'-1	377	337	304	276	252	232	214	159	146	134	123	113	104	96	89
	3VLI18	11'-4	13'-9	13'-10	400	371	338	309	285	264	246	229	215	162	151	140	131	122	115
	3VLI16	11'-7	13'-10	14'-3	400	400	378	345	317	293	272	253	237	222	169	157	146	136	128
7.00 (t=4.00) 69 PSF	3VLI22	7'-9	7'-8	8'-8	338	304	233	209	188	171	155	142	130	119	109	101	93	86	79
	3VLI20	9'-0	10'-11	11'-4	377	338	305	278	255	192	174	159	145	133	122	113	104	96	89
	3VLI19	10'-1	12'-2	12'-7	400	370	334	303	277	255	236	175	160	147	135	124	115	106	98
	3VLI18	11'-0	13'-3	13'-6	400	400	371	340	313	290	270	252	236	178	166	154	144	135	126
	3VLI16	11'-4	13'-4	13'-9	400	400	400	379	348	322	298	278	260	200	185	172	161	150	140
7.50 (t=4.50) 75 PSF	3VLI22	7'-7	7'-2	8'-2	368	331	254	228	205	186	169	154	141	130	119	110	101	93	86
	3VLI20	8'-9	10'-2	10'-11	400	368	333	303	231	209	190	173	158	145	134	123	113	105	97
	3VLI19	9'-10	11'-9	12'-2	400	400	364	331	302	278	209	191	175	160	147	136	125	116	107
	3VLI18	10'-9	12'-10	13'-3	400	400	400	370	341	316	294	275	210	195	181	168	157	147	138
	3VLI16	11'-0	12'-11	13'-4	400	400	400	400	380	351	325	303	283	218	202	188	175	164	153

- Notes:
1. Minimum exterior bearing length required is 2.50 inches. Minimum interior bearing length required is 5.00 inches. If these minimum lengths are not provided, web crippling must be checked.
 2. Always contact Vulcraft when using loads in excess of 200 psf. Such loads often result from concentrated, dynamic, or long term load cases for which reductions due to bond breakage, concrete creep, etc. should be evaluated.
 3. All fire rated assemblies are subject to an upper live load limit of 250 psf.
 4. 3/4 in. diameter welded shear stud utilized for calculations.
 5. Refer to AISC for further stud material and installation requirements.

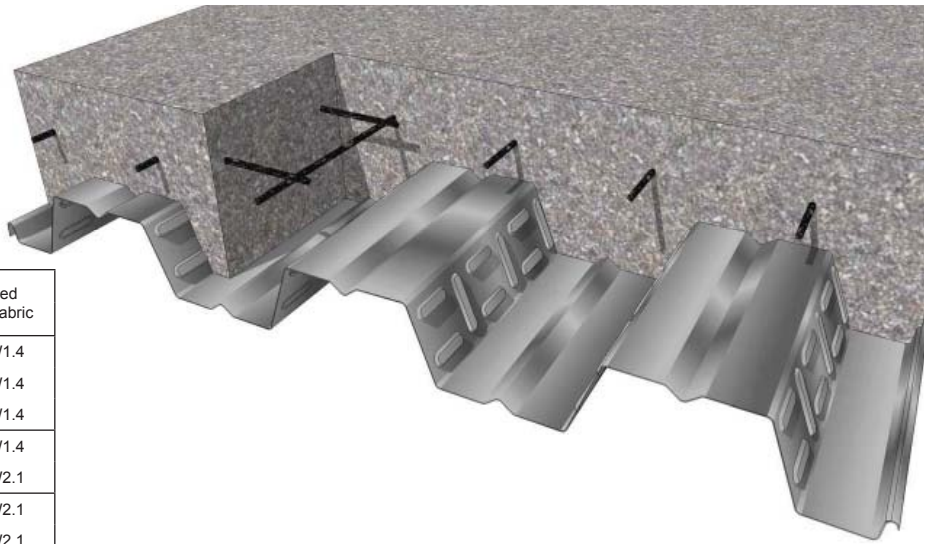

SLAB INFORMATION

Total Slab Depth, in.	Theoretical Concrete Volume		Recommended Welded Wire Fabric
	Yd ³ / 100 ft ²	ft ³ / ft ²	
5	1.08	0.292	6x6 - W1.4xW1.4
5 1/2	1.23	0.333	6x6 - W1.4xW1.4
6	1.39	0.375	6x6 - W1.4xW1.4
6 1/4	1.47	0.396	6x6 - W1.4xW1.4
6 1/2	1.54	0.417	6x6 - W2.1xW2.1
7	1.70	0.458	6x6 - W2.1xW2.1
7 1/4	1.77	0.479	6x6 - W2.1xW2.1
7 1/2	1.85	0.500	6x6 - W2.1xW2.1

(N=14.15) LIGHTWEIGHT CONCRETE (110 PCF)

Total Slab Depth	Deck Type	SDI Max. Unshored Clear Span			Superimposed Live Load (PSF) Clear Span (ft.-in.)														
		1 Span	2 Span	3 Span	8'-0	8'-6	9'-0	9'-6	10'-0	10'-6	11'-0	11'-6	12'-0	12'-6	13'-0	13'-6	14'-0	14'-6	15'-0
5.50 (t=2.50) 39 PSF	3VLI22	9'-8	11'-7	12'-2	161	145	131	120	85	77	69	62	56	51	46	42			
	3VLI20	11'-3	13'-6	14'-0	186	167	151	138	126	116	107	74	67	61	56	51	46	42	
	3VLI19	12'-8	15'-0	15'-1	211	189	171	155	142	130	120	111	103	96	65	59	54	49	45
	3VLI18	13'-4	15'-7	15'-7	278	253	232	214	198	184	172	161	152	143	135	103	97	91	85
	3VLI16	14'-0	16'-4	16'-5	316	289	267	247	230	215	202	190	179	170	161	153	146	114	107
6.00 (t=3.00) 44 PSF	3VLI22	9'-3	10'-9	11'-8	181	163	147	107	96	86	78	70	63	57	52	47	43		
	3VLI20	10'-9	13'-0	13'-6	209	188	170	155	141	130	93	84	76	69	63	57	52	47	43
	3VLI19	12'-1	14'-5	14'-8	237	212	192	174	159	146	135	125	116	80	73	67	61	56	51
	3VLI18	12'-11	15'-2	15'-2	312	284	261	240	223	207	193	181	170	161	124	116	109	102	96
	3VLI16	13'-7	15'-9	16'-0	354	325	299	277	258	241	226	213	201	190	181	172	135	128	121
6.25 (t=3.25) 46 PSF	3VLI22	9'-1	10'-4	11'-6	191	172	155	113	101	91	82	74	67	60	55	50	45	41	
	3VLI20	10'-6	12'-10	13'-3	221	198	179	163	149	137	98	88	80	73	66	60	55	50	46
	3VLI19	11'-10	14'-2	14'-6	250	224	202	184	168	154	142	131	93	84	77	70	64	59	54
	3VLI18	12'-9	15'-0	15'-0	329	300	275	253	235	218	204	191	180	169	131	122	115	108	101
	3VLI16	13'-4	15'-5	15'-10	374	343	316	293	272	254	239	225	212	201	190	151	143	135	128
6.50 (t=3.50) 48 PSF	3VLI22	8'-11	10'-0	11'-3	200	180	134	119	107	96	86	78	70	64	58	52	47	43	
	3VLI20	10'-4	12'-7	13'-0	232	209	189	172	157	114	103	93	84	77	70	63	58	53	48
	3VLI19	11'-7	13'-11	14'-4	263	236	213	193	176	162	149	138	98	89	81	74	68	62	57
	3VLI18	12'-7	14'-9	14'-9	346	316	289	267	247	230	215	201	189	178	138	129	121	113	107
	3VLI16	13'-0	15'-2	15'-7	393	360	332	308	286	268	251	236	223	211	200	159	150	142	134
7.25 (t=4.25) 55 PSF	3VLI22	8'-5	9'-1	10'-4	230	173	153	137	122	110	99	89	81	73	66	60	55	49	45
	3VLI20	9'-9	12'-0	12'-4	267	240	217	197	146	131	118	107	97	88	80	73	66	61	55
	3VLI19	10'-11	13'-3	13'-9	302	271	244	222	203	186	137	124	112	102	93	85	78	71	65
	3VLI18	12'-0	14'-4	14'-4	398	362	332	306	284	264	246	231	217	169	158	148	139	130	123
	3VLI16	12'-4	14'-6	15'-0	400	400	381	353	329	307	288	271	256	207	194	183	173	163	154

- Notes:
1. Minimum exterior bearing length required is 2.50 inches. Minimum interior bearing length required is 5.00 inches. If these minimum lengths are not provided, web crippling must be checked.
 2. Always contact Vulcraft when using loads in excess of 200 psf. Such loads often result from concentrated, dynamic, or long term load cases for which reductions due to bond breakage, concrete creep, etc. should be evaluated.
 3. All fire rated assemblies are subject to an upper live load limit of 250 psf.
 4. 3/4 in. diameter welded shear stud utilized for calculations.
 5. Refer to AISC for further stud material and installation requirements.

3VLI - NO STUDS

3 VLI Stud Spacing - 12in C-C

Maximum Sheet Length 42'-0"
Extra charge for lengths under 6'-0"
ICBO Approved (No. 3415)

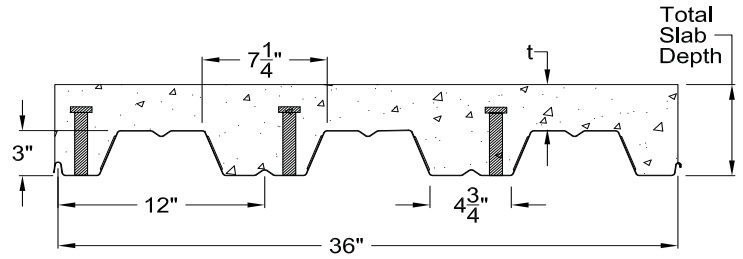

Interlocking side lap is not drawn to show actual detail.

STEEL SECTION PROPERTIES

Deck type	Design thickness (in.)	Weight psf	Section Properties				A _s in ² /ft	ΦV _n lbs/ft	N (Normal Wt. Concrete) studs/ft	N (Lightweight Concrete) studs/ft	F _y ksi
			I _p in ⁴ /ft	S _p in ³ /ft	I _n in ⁴ /ft	S _n in ³ /ft					
3VLI22	0.0295	1.77	0.730	0.414	0.729	0.426	0.504	2139	0.620	0.763	50
3VLI20	0.0358	2.14	0.920	0.534	0.919	0.551	0.612	3777	0.753	0.926	50
3VLI19	0.0418	2.50	1.104	0.654	1.102	0.676	0.715	5152	0.879	1.081	50
3VLI18	0.0474	2.84	1.254	0.770	1.252	0.797	0.810	6628	0.997	1.226	50
3VLI16	0.0598	3.58	1.580	1.013	1.580	1.013	1.023	7449	1.006	1.238	40

(N=9.35) NORMAL WEIGHT CONCRETE (145 PCF)

Total Slab Depth	Deck Type	SDI Max. Unshored Clear Span			A _c in ² /ft	ΦV _n lb/ft	Superimposed Live Load (PSF) - Shear Studs at 12 in. c/c Clear Span (ft.-in.)														
		1 Span	2 Span	3 Span			7'-0	7'-6	8'-0	8'-6	9'-0	9'-6	10'-0	10'-6	11'-0	11'-6	12'-0	12'-6	13'-0	13'-6	14'-0
5.50 (t=2.50) 51 PSF	3VLI22	8'-9	9'-8	10'-11	38.73	5745	400	400	400	400	364	323	287	257	231	208	187	170	154	140	127
	3VLI20	10'-1	12'-4	12'-9	38.73	7212	400	400	400	400	400	389	347	311	280	253	229	208	189	173	158
	3VLI19	11'-4	13'-8	14'-2	38.73	7212	400	400	400	400	400	400	400	361	325	294	267	243	221	202	181
	3VLI18	12'-5	14'-7	14'-7	38.73	7212	400	400	400	400	400	400	400	400	365	330	300	267	238	212	190
	3VLI16	12'-9	14'-11	15'-5	38.73	7212	400	400	399	399	399	399	366	329	296	267	242	220	200	183	167
6.00 (t=3.00) 57 PSF	3VLI22	8'-4	8'-10	10'-1	43.50	6189	400	400	400	400	400	367	327	293	263	237	214	194	175	159	145
	3VLI20	9'-8	11'-10	12'-3	43.50	7828	400	400	400	400	400	400	397	356	321	289	262	238	217	198	181
	3VLI19	10'-10	13'-2	13'-7	43.50	8101	400	400	400	400	400	400	400	400	373	337	306	279	254	232	213
	3VLI18	11'-10	14'-2	14'-2	43.50	8101	400	400	400	400	400	400	400	400	400	380	345	315	288	263	242
	3VLI16	12'-2	14'-4	14'-10	43.50	8101	400	400	400	399	399	399	399	376	339	306	278	252	230	210	192
6.50 (t=3.50) 63 PSF	3VLI22	8'-0	8'-3	9'-4	48.48	6653	400	400	400	400	400	400	367	329	295	266	240	217	197	179	163
	3VLI20	9'-3	11'-5	11'-9	48.48	8291	400	400	400	400	400	400	400	400	361	326	295	268	244	223	204
	3VLI19	10'-4	12'-8	13'-1	48.48	9028	400	400	400	400	400	400	400	400	400	381	346	315	287	263	241
	3VLI18	11'-4	13'-9	13'-10	48.48	9028	400	400	400	400	400	400	400	400	400	400	391	356	325	298	274
	3VLI16	11'-7	13'-10	14'-3	48.48	9028	400	400	400	400	399	399	399	399	381	345	313	284	259	236	216
7.00 (t=4.00) 69 PSF	3VLI22	7'-9	7'-8	8'-8	53.67	7136	400	400	400	400	400	400	400	365	328	295	267	241	219	199	181
	3VLI20	9'-0	10'-11	11'-4	53.67	8774	400	400	400	400	400	400	400	400	400	362	328	298	272	248	226
	3VLI19	10'-1	12'-2	12'-7	53.67	9994	400	400	400	400	400	400	400	400	400	400	385	350	320	293	268
	3VLI18	11'-0	13'-3	13'-6	53.67	9994	400	400	400	400	400	400	400	400	400	400	400	397	363	333	306
	3VLI16	11'-4	13'-4	13'-9	53.67	9994	400	400	400	400	400	400	399	399	399	383	348	316	288	263	241
7.50 (t=4.50) 75 PSF	3VLI22	7'-7	7'-2	8'-2	59.06	7638	400	400	400	400	400	400	400	400	360	324	293	265	241	219	199
	3VLI20	8'-9	10'-2	10'-11	59.06	9277	400	400	400	400	400	400	400	400	400	399	361	328	299	273	249
	3VLI19	9'-10	11'-9	12'-2	59.06	10652	400	400	400	400	400	400	400	400	400	400	400	386	353	323	296
	3VLI18	10'-9	12'-10	13'-3	59.06	10999	400	400	400	400	400	400	400	400	400	400	400	400	400	368	338
	3VLI16	11'-0	12'-11	13'-4	59.06	10999	400	400	400	400	400	400	400	399	399	399	383	348	318	290	266

- Notes:
1. Minimum exterior bearing length required is 2.50 inches. Minimum interior bearing length required is 5.00 inches. If these minimum lengths are not provided, web crippling must be checked.
 2. Always contact Vulcraft when using loads in excess of 200 psf. Such loads often result from concentrated, dynamic, or long term load cases for which reductions due to bond breakage, concrete creep, etc. should be evaluated.
 3. All fire rated assemblies are subject to an upper live load limit of 250 psf.
 4. 3/4 in. diameter welded shear stud utilized for calculations.
 5. Refer to AISC for further stud material and installation requirements.

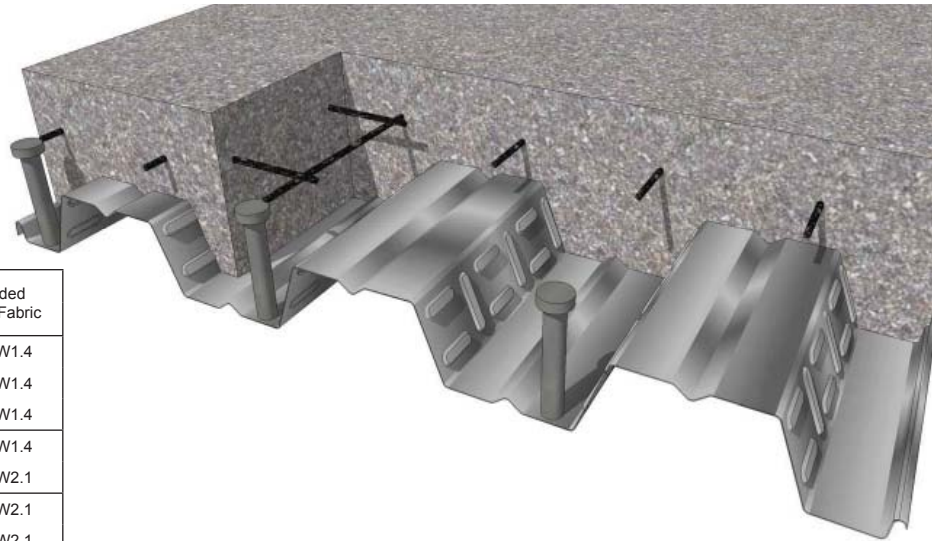

SLAB INFORMATION

Total Slab Depth, in.	Theoretical Concrete Volume		Recommended Welded Wire Fabric
	Yd ³ / 100 ft ²	ft ³ / ft ²	
5	1.08	0.292	6x6 - W1.4xW1.4
5 1/2	1.23	0.333	6x6 - W1.4xW1.4
6	1.39	0.375	6x6 - W1.4xW1.4
6 1/4	1.47	0.396	6x6 - W1.4xW1.4
6 1/2	1.54	0.417	6x6 - W2.1xW2.1
7	1.70	0.458	6x6 - W2.1xW2.1
7 1/4	1.77	0.479	6x6 - W2.1xW2.1
7 1/2	1.85	0.500	6x6 - W2.1xW2.1

(N=14.15) LIGHTWEIGHT CONCRETE (110 PCF)

Total Slab Depth	Deck Type	SDI Max. Unshored Clear Span			A _c in ² /ft	ΦV _m lb/ft	Superimposed Live Load (PSF) - Shear Studs at 12 in. c/c														
		1 Span	2 Span	3 Span			Clear Span (ft.-in.)														
5.50 (t=2.50) 39 PSF	3VLI22	9'-8"	11'-7"	12'-2"	38.73	4843	400	400	373	331	296	266	240	217	194	172	153	136	122	110	99
	3VLI20	11'-3"	13'-6"	14'-0"	38.73	5409	400	400	400	398	356	312	271	238	209	185	164	147	132	119	107
	3VLI19	12'-8"	15'-0"	15'-1"	38.73	5409	386	384	383	382	381	333	289	253	223	197	175	156	140	126	114
	3VLI18	13'-4"	15'-7"	15'-7"	38.73	5409	377	373	369	366	363	351	305	267	235	208	185	165	148	133	120
	3VLI16	14'-0"	16'-4"	16'-5"	38.73	5409	384	379	374	371	348	315	286	260	238	218	201	183	164	148	133
6.00 (t=3.00) 44 PSF	3VLI22	9'-3"	10'-9"	11'-8"	43.50	5177	400	400	400	377	337	303	273	247	224	204	186	170	155	140	127
	3VLI20	10'-9"	13'-0"	13'-6"	43.50	6076	400	400	400	400	400	366	331	300	266	236	210	187	168	151	136
	3VLI19	12'-1"	14'-5"	14'-8"	43.50	6076	388	386	384	383	382	381	364	322	284	251	223	199	179	161	145
	3VLI18	12'-11"	15'-2"	15'-2"	43.50	6076	384	379	374	371	367	364	362	339	299	264	235	210	188	169	153
	3VLI16	13'-7"	15'-9"	16'-0"	43.50	6076	391	386	381	376	373	359	326	297	271	249	229	211	190	175	162
6.25 (t=3.25) 46 PSF	3VLI22	9'-1"	10'-4"	11'-6"	45.96	5349	400	400	400	400	358	322	290	262	238	216	197	180	165	151	139
	3VLI20	10'-6"	12'-10"	13'-3"	45.96	6420	400	400	400	400	400	389	351	318	289	264	235	210	188	169	153
	3VLI19	11'-10"	14'-2"	14'-6"	45.96	6420	389	387	385	384	383	381	381	352	318	281	250	223	200	180	163
	3VLI18	12'-9"	15'-0"	15'-0"	45.96	6420	387	382	377	373	370	366	364	361	335	296	263	235	211	190	171
	3VLI16	13'-4"	15'-5"	15'-10"	45.96	6420	395	389	384	379	375	372	346	315	288	264	243	218	201	186	172
6.50 (t=3.50) 48 PSF	3VLI22	8'-11"	10'-0"	11'-3"	48.48	5524	400	400	400	400	379	340	307	277	252	229	209	191	175	160	147
	3VLI20	10'-4"	12'-7"	13'-0"	48.48	6771	400	400	400	400	400	400	372	337	307	280	256	234	210	189	171
	3VLI19	11'-7"	13'-11"	14'-4"	48.48	6771	390	388	386	384	383	382	381	373	337	308	279	249	223	201	182
	3VLI18	12'-7"	14'-9"	14'-9"	48.48	6771	390	384	380	375	372	369	366	363	361	330	294	262	235	212	191
	3VLI16	13'-0"	15'-2"	15'-7"	48.48	6771	399	392	387	382	378	375	366	334	305	280	257	231	213	197	182
7.25 (t=4.25) 55 PSF	3VLI22	8'-5"	9'-1"	10'-4"	56.34	6073	400	400	400	400	400	396	357	323	293	267	243	222	204	187	171
	3VLI20	9'-9"	12'-0"	12'-4"	56.34	7712	400	400	400	400	400	400	400	393	358	326	298	274	251	231	213
	3VLI19	10'-11"	13'-3"	13'-9"	56.34	7869	393	390	388	387	385	384	380	379	378	360	330	303	279	257	237
	3VLI18	12'-0"	14'-4"	14'-4"	56.34	7869	400	393	387	383	378	375	372	369	366	357	352	324	299	276	256
	3VLI16	12'-4"	14'-6"	15'-0"	56.34	7869	400	400	396	391	386	382	379	375	356	319	293	270	249	230	213

- Notes:
1. Minimum exterior bearing length required is 2.50 inches. Minimum interior bearing length required is 5.00 inches. If these minimum lengths are not provided, web crippling must be checked.
 2. Always contact Vulcraft when using loads in excess of 200 psf. Such loads often result from concentrated, dynamic, or long term load cases for which reductions due to bond breakage, concrete creep, etc. should be evaluated.
 3. All fire rated assemblies are subject to an upper live load limit of 250 psf.
 4. 3/4 in. diameter welded shear stud utilized for calculations.
 5. Refer to AISC for further stud material and installation requirements.

3VLI - 12in C-C

3 VLI Stud Spacing - 24in C-C

Maximum Sheet Length 42'-0"
Extra charge for lengths under 6'-0"
ICBO Approved (No. 3415)

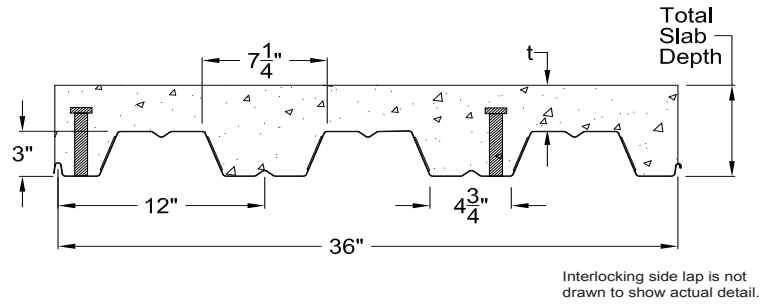

STEEL SECTION PROPERTIES

Deck type	Design thickness (in.)	Weight psf	Section Properties				A _s in ² /ft	ΦV _n lbs/ft	N (Normal Wt. Concrete) studs/ft	N (Lightweight Concrete) studs/ft	F _y ksi
			I _p in ⁴ /ft	S _p in ³ /ft	I _n in ⁴ /ft	S _n in ³ /ft					
3VLI22	0.0295	1.77	0.730	0.414	0.729	0.426	0.504	2139	0.620	0.763	50
3VLI20	0.0358	2.14	0.920	0.534	0.919	0.551	0.612	3777	0.753	0.926	50
3VLI19	0.0418	2.50	1.104	0.654	1.102	0.676	0.715	5152	0.879	1.081	50
3VLI18	0.0474	2.84	1.254	0.770	1.252	0.797	0.810	6628	0.997	1.226	50
3VLI16	0.0598	3.58	1.580	1.013	1.580	1.013	1.023	7449	1.006	1.238	40

(N=9.35) NORMAL WEIGHT CONCRETE (145 PCF)

Total Slab Depth	Deck Type	SDI Max. Unshored Clear Span			A _c in ² /ft	ΦV _n lb/ft	Superimposed Live Load (PSF) - Shear Studs at 24 in. c/c Clear Span (ft.-in.)														
		1 Span	2 Span	3 Span			7'-0	7'-6	8'-0	8'-6	9'-0	9'-6	10'-0	10'-6	11'-0	11'-6	12'-0	12'-6	13'-0	13'-6	14'-0
5.50 (t=2.50) 51 PSF	3VLI22	8'-9	9'-8	10'-11	38.73	5745	370	365	361	358	320	284	253	227	204	184	167	151	137	125	113
	3VLI20	10'-1	12'-4	12'-9	38.73	7212	358	348	341	334	328	316	284	246	222	201	182	166	151	138	126
	3VLI19	11'-4	13'-8	14'-2	38.73	7212	358	344	333	323	315	308	302	274	249	213	194	177	162	148	136
	3VLI18	12'-5	14'-7	14'-7	38.73	7212	365	349	336	324	315	306	299	292	269	247	227	193	178	164	151
	3VLI16	12'-9	14'-11	15'-5	38.73	7212	386	367	352	338	327	317	292	266	243	223	205	189	159	146	135
6.00 (t=3.00) 57 PSF	3VLI22	8'-4	8'-10	10'-1	43.50	6189	376	371	366	356	352	323	289	259	233	210	190	172	156	142	129
	3VLI20	9'-8	11'-10	12'-3	43.50	7828	369	359	350	342	336	330	312	280	253	229	208	189	173	158	144
	3VLI19	10'-10	13'-2	13'-7	43.50	8101	374	358	346	335	326	318	311	305	269	244	222	202	185	170	156
	3VLI18	11'-10	14'-2	14'-2	43.50	8101	385	367	352	340	329	319	311	304	297	282	241	221	203	187	173
	3VLI16	12'-2	14'-4	14'-10	43.50	8101	400	388	370	355	343	332	322	302	276	253	233	197	181	166	153
6.50 (t=3.50) 63 PSF	3VLI22	8'-0	8'-3	9'-4	48.48	6653	382	376	371	359	356	352	324	290	261	235	213	193	175	159	145
	3VLI20	9'-3	11'-5	11'-9	48.48	8291	381	369	359	351	344	324	319	314	284	257	233	213	194	177	162
	3VLI19	10'-4	12'-8	13'-1	48.48	9028	390	373	359	347	336	328	320	296	290	274	249	228	208	191	175
	3VLI18	11'-4	13'-9	13'-10	48.48	9028	400	386	369	355	343	332	323	315	308	281	271	249	229	211	194
	3VLI16	11'-7	13'-10	14'-3	48.48	9028	400	400	389	373	358	346	335	326	309	284	241	220	203	186	172
7.00 (t=4.00) 69 PSF	3VLI22	7'-9	7'-8	8'-8	53.67	7136	388	381	368	363	359	355	352	321	289	261	236	214	194	177	161
	3VLI20	9'-0	10'-11	11'-4	53.67	8774	392	379	368	359	351	330	324	319	314	285	259	236	215	197	180
	3VLI19	10'-1	12'-2	12'-7	53.67	9994	400	387	371	358	347	337	329	303	297	291	277	253	231	212	195
	3VLI18	11'-0	13'-3	13'-6	53.67	9994	400	400	386	370	357	345	335	326	318	290	283	276	254	234	216
	3VLI16	11'-4	13'-4	13'-9	53.67	9994	400	400	400	390	374	361	349	339	330	292	266	244	224	207	191
7.50 (t=4.50) 75 PSF	3VLI22	7'-7	7'-2	8'-2	59.06	7638	394	387	372	367	362	358	355	352	317	286	259	235	214	194	177
	3VLI20	8'-9	10'-2	10'-11	59.06	9277	400	389	377	367	343	336	329	324	319	313	285	259	237	216	198
	3VLI19	9'-10	11'-9	12'-2	59.06	10652	400	400	384	370	358	347	318	310	303	297	291	278	255	233	214
	3VLI18	10'-9	12'-10	13'-3	59.06	10999	400	400	400	385	371	358	347	338	305	298	291	285	279	258	238
	3VLI16	11'-0	12'-11	13'-4	59.06	10999	400	400	400	400	390	375	362	351	341	308	292	268	246	227	209

- Notes:
1. Minimum exterior bearing length required is 2.50 inches. Minimum interior bearing length required is 5.00 inches. If these minimum lengths are not provided, web crippling must be checked.
 2. Always contact Vulcraft when using loads in excess of 200 psf. Such loads often result from concentrated, dynamic, or long term load cases for which reductions due to bond breakage, concrete creep, etc. should be evaluated.
 3. All fire rated assemblies are subject to an upper live load limit of 250 psf.
 4. 3/4 in. diameter welded shear stud utilized for calculations.
 5. Refer to AISC for further stud material and installation requirements.

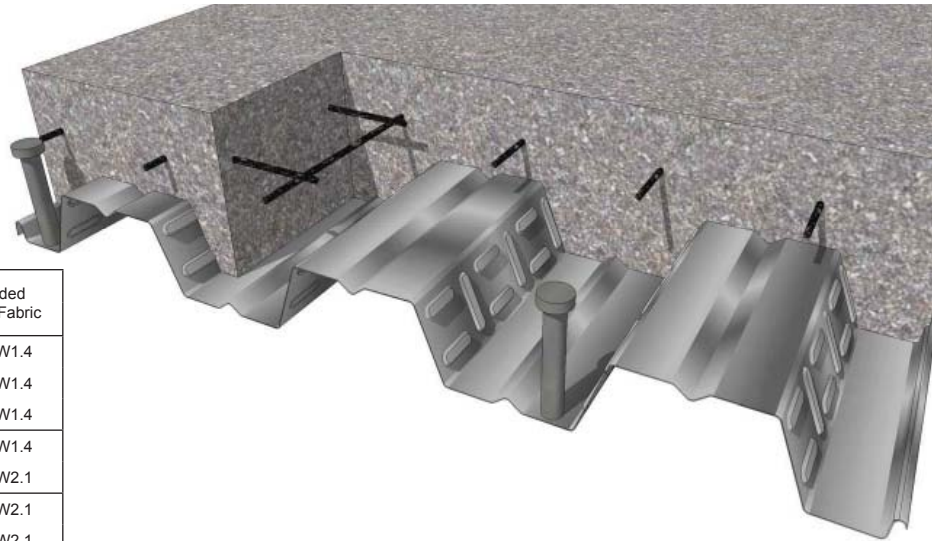

SLAB INFORMATION

Total Slab Depth, in.	Theoretical Concrete Volume		Recommended Welded Wire Fabric
	Yd ³ / 100 ft ²	ft ³ / ft ²	
5	1.08	0.292	6x6 - W1.4xW1.4
5 1/2	1.23	0.333	6x6 - W1.4xW1.4
6	1.39	0.375	6x6 - W1.4xW1.4
6 1/4	1.47	0.396	6x6 - W1.4xW1.4
6 1/2	1.54	0.417	6x6 - W2.1xW2.1
7	1.70	0.458	6x6 - W2.1xW2.1
7 1/4	1.77	0.479	6x6 - W2.1xW2.1
7 1/2	1.85	0.500	6x6 - W2.1xW2.1

(N=14.15) LIGHTWEIGHT CONCRETE (110 PCF)

Total Slab Depth	Deck Type	SDI Max. Unshored Clear Span			A _c in ² /ft	ΦV _{nt} lb/ft	Superimposed Live Load (PSF) - Shear Studs at 24 in. c/c														
		1 Span	2 Span	3 Span			Clear Span (ft.-in.)														
							8'-0	8'-6	9'-0	9'-6	10'-0	10'-6	11'-0	11'-6	12'-0	12'-6	13'-0	13'-6	14'-0	14'-6	15'-0
5.50 (t=2.50) 39 PSF	3VLI22	9'-8	11'-7	12'-2	38.73	4843	318	312	289	258	224	201	181	163	148	135	123	112	102	94	86
	3VLI20	11'-3	13'-6	14'-0	38.73	5409	302	293	286	278	250	226	205	176	160	145	133	121	111	102	94
	3VLI19	12'-8	15'-0	15'-1	38.73	5409	298	287	277	268	261	241	219	200	183	168	141	130	119	109	101
	3VLI18	13'-4	15'-7	15'-7	38.73	5409	328	313	301	290	280	272	254	234	216	200	185	158	146	133	120
	3VLI16	14'-0	16'-4	16'-5	38.73	5409	350	334	321	309	289	265	244	225	208	194	181	169	158	133	125
6.00 (t=3.00) 44 PSF	3VLI22	9'-3	10'-9	11'-8	43.50	5177	324	318	313	284	254	228	206	186	169	153	140	127	117	107	98
	3VLI20	10'-9	13'-0	13'-6	43.50	6076	312	302	294	287	281	257	221	200	182	166	151	139	127	117	107
	3VLI19	12'-1	14'-5	14'-8	43.50	6076	312	299	288	279	270	263	249	228	208	177	161	148	136	125	115
	3VLI18	12'-11	15'-2	15'-2	43.50	6076	348	332	318	305	295	286	278	266	246	228	195	180	167	155	144
	3VLI16	13'-7	15'-9	16'-0	43.50	6076	373	355	340	327	315	300	276	255	236	220	205	191	162	151	141
6.25 (t=3.25) 46 PSF	3VLI22	9'-1	10'-4	11'-6	45.96	5349	328	321	316	301	269	242	218	197	179	163	148	135	124	113	104
	3VLI20	10'-6	12'-10	13'-3	45.96	6420	318	307	298	291	285	273	235	213	193	176	161	147	135	124	114
	3VLI19	11'-10	14'-2	14'-6	45.96	6420	319	305	294	284	275	268	261	242	206	188	172	157	144	133	122
	3VLI18	12'-9	15'-0	15'-0	45.96	6420	358	341	326	313	302	292	284	276	261	242	207	191	177	165	153
	3VLI16	13'-4	15'-5	15'-10	45.96	6420	384	366	350	336	324	313	292	270	250	233	217	185	172	160	150
6.50 (t=3.50) 48 PSF	3VLI22	8'-11	10'-0	11'-3	48.48	5524	331	324	308	303	285	256	231	208	189	172	157	143	131	120	110
	3VLI20	10'-4	12'-7	13'-0	48.48	6771	323	312	303	295	288	268	248	225	204	186	170	156	143	131	120
	3VLI19	11'-7	13'-11	14'-4	48.48	6771	326	312	299	289	280	272	265	255	217	198	182	166	153	141	130
	3VLI18	12'-7	14'-9	14'-9	48.48	6771	368	350	334	321	309	299	290	282	275	255	219	202	188	174	162
	3VLI16	13'-0	15'-2	15'-7	48.48	6771	396	376	360	345	332	321	309	285	264	245	229	195	182	169	158
7.25 (t=4.25) 55 PSF	3VLI22	8'-5	9'-1	10'-4	56.34	6073	341	322	315	309	304	297	268	242	220	200	182	166	152	139	128
	3VLI20	9'-9	12'-0	12'-4	56.34	7712	339	326	316	307	283	276	270	262	238	217	198	181	166	153	140
	3VLI19	10'-11	13'-3	13'-9	56.34	7869	347	330	316	304	294	285	258	251	245	231	212	194	178	164	151
	3VLI18	12'-0	14'-4	14'-4	56.34	7869	399	378	360	344	331	319	309	300	292	263	255	236	219	203	189
	3VLI16	12'-4	14'-6	15'-0	56.34	7869	400	400	389	372	358	345	333	323	306	263	244	226	211	197	184

- Notes:
1. Minimum exterior bearing length required is 2.50 inches. Minimum interior bearing length required is 5.00 inches. If these minimum lengths are not provided, web crippling must be checked.
 2. Always contact Vulcraft when using loads in excess of 200 psf. Such loads often result from concentrated, dynamic, or long term load cases for which reductions due to bond breakage, concrete creep, etc. should be evaluated.
 3. All fire rated assemblies are subject to an upper live load limit of 250 psf.
 4. 3/4 in. diameter welded shear stud utilized for calculations.
 5. Refer to AISC for further stud material and installation requirements.

3VLI - 24in C-C

3 VLI Stud Spacing - 36in C-C

Maximum Sheet Length 42'-0"
Extra charge for lengths under 6'-0"
ICBO Approved (No. 3415)

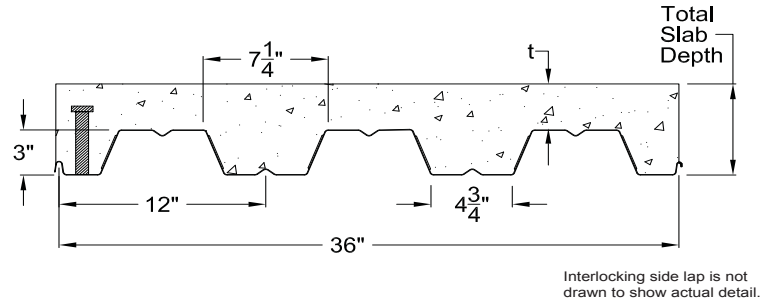

STEEL SECTION PROPERTIES

Deck type	Design thickness (in.)	Weight psf	Section Properties				A _s in ² /ft	ΦV _n lbs/ft	N (Normal Wt. Concrete) studs/ft	N (Lightweight Concrete) studs/ft	F _y ksi
			I _p in ⁴ /ft	S _p in ³ /ft	I _n in ⁴ /ft	S _n in ³ /ft					
3VLI22	0.0295	1.77	0.730	0.414	0.729	0.426	0.504	2139	0.620	0.763	50
3VLI20	0.0358	2.14	0.920	0.534	0.919	0.551	0.612	3777	0.753	0.926	50
3VLI19	0.0418	2.50	1.104	0.654	1.102	0.676	0.715	5152	0.879	1.081	50
3VLI18	0.0474	2.84	1.254	0.770	1.252	0.797	0.810	6628	0.997	1.226	50
3VLI16	0.0598	3.58	1.580	1.013	1.580	1.013	1.023	7449	1.006	1.238	40

(N=9.35) NORMAL WEIGHT CONCRETE (145 PCF)

Total Slab Depth	Deck Type	SDI Max. Unshored Clear Span			A _c in ² /ft	ΦV _n lb/ft	Superimposed Live Load (PSF) - Shear Studs at 36 in. c/c														
		1 Span	2 Span	3 Span			7'-0	7'-6	8'-0	8'-6	9'-0	9'-6	10'-0	10'-6	11'-0	11'-6	12'-0	12'-6	13'-0	13'-6	14'-0
5.50 (t=2.50) 51 PSF	3VLI22	8'-9	9'-8	10'-11	38.73	5745	329	318	308	300	259	231	207	186	168	152	138	125	114	104	95
	3VLI20	10'-1	12'-4	12'-9	38.73	7212	330	315	301	290	281	268	242	202	183	166	151	138	126	115	106
	3VLI19	11'-4	13'-8	14'-2	38.73	7212	339	319	303	289	277	267	259	236	216	178	162	148	136	125	115
	3VLI18	12'-5	14'-7	14'-7	38.73	7212	353	332	314	299	286	275	265	256	237	219	202	166	153	142	131
	3VLI16	12'-9	14'-11	15'-5	38.73	7212	382	357	336	318	303	290	268	245	225	208	193	179	145	134	124
6.00 (t=3.00) 57 PSF	3VLI22	8'-4	8'-10	10'-1	43.50	6189	343	330	320	294	286	262	235	211	190	172	156	142	129	118	108
	3VLI20	9'-8	11'-10	12'-3	43.50	7828	349	331	317	304	294	284	255	230	208	189	172	157	143	131	120
	3VLI19	10'-10	13'-2	13'-7	43.50	8101	362	340	322	306	293	282	272	263	223	203	185	169	155	142	131
	3VLI18	11'-10	14'-2	14'-2	43.50	8101	380	356	336	319	305	292	281	271	263	248	206	189	175	161	149
	3VLI16	12'-2	14'-4	14'-10	43.50	8101	400	384	361	341	324	309	296	277	255	236	218	178	164	152	141
6.50 (t=3.50) 63 PSF	3VLI22	8'-0	8'-3	9'-4	48.48	6653	357	343	331	303	294	287	263	236	213	193	175	159	145	132	121
	3VLI20	9'-3	11'-5	11'-9	48.48	8291	368	348	332	318	306	274	265	258	233	212	193	176	161	147	135
	3VLI19	10'-4	12'-8	13'-1	48.48	9028	385	361	340	323	308	296	285	251	242	227	207	189	174	159	147
	3VLI18	11'-4	13'-9	13'-10	48.48	9028	400	381	359	340	323	309	297	286	277	242	231	213	196	181	168
	3VLI16	11'-7	13'-10	14'-3	48.48	9028	400	400	386	364	345	328	314	302	285	263	217	199	184	170	157
7.00 (t=4.00) 69 PSF	3VLI22	7'-9	7'-8	8'-8	53.67	7136	371	356	323	312	302	294	287	261	236	214	194	176	161	146	134
	3VLI20	9'-0	10'-11	11'-4	53.67	8774	387	365	347	332	319	284	274	266	258	235	214	195	178	163	150
	3VLI19	10'-1	12'-2	12'-7	53.67	9994	400	381	359	340	324	310	298	260	251	243	230	210	193	177	163
	3VLI18	11'-0	13'-3	13'-6	53.67	9994	400	400	381	360	342	327	313	302	291	252	244	236	217	201	186
	3VLI16	11'-4	13'-4	13'-9	53.67	9994	400	400	400	386	366	348	332	318	306	261	239	220	203	188	174
7.50 (t=4.50) 75 PSF	3VLI22	7'-7	7'-2	8'-2	59.06	7638	385	368	332	320	310	301	293	286	259	234	213	193	176	161	147
	3VLI20	8'-9	10'-2	10'-11	59.06	9277	400	382	363	346	306	293	283	274	265	257	234	214	196	179	164
	3VLI19	9'-10	11'-9	12'-2	59.06	10652	400	400	378	357	339	324	282	270	260	251	243	231	211	194	179
	3VLI18	10'-9	12'-10	13'-3	59.06	10999	400	400	400	380	361	344	329	317	273	263	254	246	238	221	204
	3VLI16	11'-0	12'-11	13'-4	59.06	10999	400	400	400	400	386	367	350	335	322	278	262	241	223	206	191

- Notes:
1. Minimum exterior bearing length required is 2.50 inches. Minimum interior bearing length required is 5.00 inches. If these minimum lengths are not provided, web crippling must be checked.
 2. Always contact Vulcraft when using loads in excess of 200 psf. Such loads often result from concentrated, dynamic, or long term load cases for which reductions due to bond breakage, concrete creep, etc. should be evaluated.
 3. All fire rated assemblies are subject to an upper live load limit of 250 psf.
 4. 3/4 in. diameter welded shear stud utilized for calculations.
 5. Refer to AISC for further stud material and installation requirements.

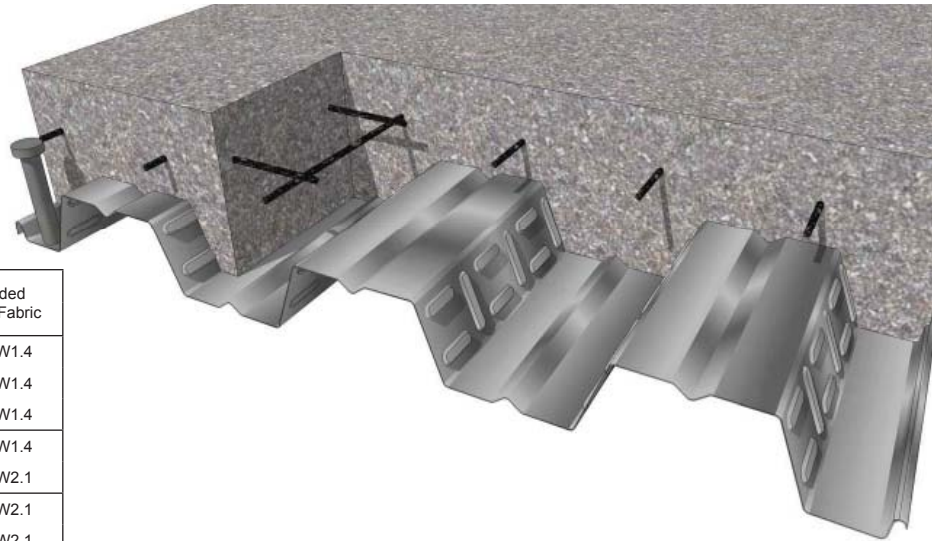

SLAB INFORMATION

Total Slab Depth, in.	Theoretical Concrete Volume		Recommended Welded Wire Fabric
	Yd ³ / 100 ft ²	ft ³ / ft ²	
5	1.08	0.292	6x6 - W1.4xW1.4
5 1/2	1.23	0.333	6x6 - W1.4xW1.4
6	1.39	0.375	6x6 - W1.4xW1.4
6 1/4	1.47	0.396	6x6 - W1.4xW1.4
6 1/2	1.54	0.417	6x6 - W2.1xW2.1
7	1.70	0.458	6x6 - W2.1xW2.1
7 1/4	1.77	0.479	6x6 - W2.1xW2.1
7 1/2	1.85	0.500	6x6 - W2.1xW2.1

(N=14.15) LIGHTWEIGHT CONCRETE (110 PCF)

Total Slab Depth	Deck Type	SDI Max. Unshored Clear Span			A _c in ² /ft	ΦV _{nt} lb/ft	Superimposed Live Load (PSF) - Shear Studs at 36 in. c/c														
		1 Span	2 Span	3 Span			Clear Span (ft.-in.)														
							8'-0	8'-6	9'-0	9'-6	10'-0	10'-6	11'-0	11'-6	12'-0	12'-6	13'-0	13'-6	14'-0	14'-6	15'-0
5.50 (t=2.50) 39 PSF	3VLI22	9'-8	11'-7	12'-2	38.73	4843	265	256	237	212	177	159	144	130	118	107	97	89	81	74	67
	3VLI20	11'-3	13'-6	14'-0	38.73	5409	263	251	241	231	209	189	173	142	129	117	107	98	90	82	75
	3VLI19	12'-8	15'-0	15'-1	38.73	5409	269	254	241	231	221	204	186	170	156	144	116	106	97	89	82
	3VLI18	13'-4	15'-7	15'-7	38.73	5409	311	293	278	265	253	243	227	210	195	181	169	140	130	121	113
	3VLI16	14'-0	16'-4	16'-5	38.73	5409	338	319	303	288	269	248	230	213	199	186	174	164	154	127	119
6.00 (t=3.00) 44 PSF	3VLI22	9'-3	10'-9	11'-8	43.50	5177	276	266	258	225	201	181	163	147	134	121	110	101	92	84	77
	3VLI20	10'-9	13'-0	13'-6	43.50	6076	278	264	253	243	235	215	178	161	147	133	122	111	102	94	86
	3VLI19	12'-1	14'-5	14'-8	43.50	6076	287	270	256	244	233	224	211	193	178	144	132	121	111	102	94
	3VLI18	12'-11	15'-2	15'-2	43.50	6076	336	316	299	284	271	260	250	238	221	205	171	159	148	137	128
	3VLI16	13'-7	15'-9	16'-0	43.50	6076	367	345	326	310	296	281	260	241	225	210	197	185	153	144	135
6.25 (t=3.25) 46 PSF	3VLI22	9'-1	10'-4	11'-6	45.96	5349	282	271	262	238	213	192	173	156	141	129	117	107	97	89	81
	3VLI20	10'-6	12'-10	13'-3	45.96	6420	285	271	259	248	239	228	189	171	155	142	129	118	108	99	91
	3VLI19	11'-10	14'-2	14'-6	45.96	6420	296	278	263	250	239	230	221	205	168	153	140	128	118	108	99
	3VLI18	12'-9	15'-0	15'-0	45.96	6420	348	327	309	293	280	268	257	248	234	218	181	168	157	146	136
	3VLI16	13'-4	15'-5	15'-10	45.96	6420	381	358	338	321	307	294	274	255	237	222	208	174	162	152	142
6.50 (t=3.50) 48 PSF	3VLI22	8'-11	10'-0	11'-3	48.48	5524	288	276	250	242	225	202	182	165	149	136	124	113	103	94	86
	3VLI20	10'-4	12'-7	13'-0	48.48	6771	293	278	265	254	244	217	200	181	164	150	137	125	114	105	96
	3VLI19	11'-7	13'-11	14'-4	48.48	6771	305	286	270	257	245	235	227	216	178	162	148	136	124	114	105
	3VLI18	12'-7	14'-9	14'-9	48.48	6771	361	339	319	303	289	276	265	255	246	230	192	178	165	154	144
	3VLI16	13'-0	15'-2	15'-7	48.48	6771	395	371	350	333	317	303	289	269	250	234	219	183	171	160	150
7.25 (t=4.25) 55 PSF	3VLI22	8'-5	9'-1	10'-4	56.34	6073	304	272	261	252	244	235	212	191	173	158	144	131	120	109	100
	3VLI20	9'-9	12'-0	12'-4	56.34	7712	315	297	283	270	237	228	220	210	191	174	159	145	133	122	112
	3VLI19	10'-11	13'-3	13'-9	56.34	7869	332	310	292	277	263	252	218	209	201	188	172	158	145	133	123
	3VLI18	12'-0	14'-4	14'-4	56.34	7869	398	373	351	332	315	301	288	277	267	232	223	207	192	179	167
	3VLI16	12'-4	14'-6	15'-0	56.34	7869	400	400	386	366	348	332	318	306	289	244	227	212	198	185	174

- Notes:
1. Minimum exterior bearing length required is 2.50 inches. Minimum interior bearing length required is 5.00 inches. If these minimum lengths are not provided, web crippling must be checked.
 2. Always contact Vulcraft when using loads in excess of 200 psf. Such loads often result from concentrated, dynamic, or long term load cases for which reductions due to bond breakage, concrete creep, etc. should be evaluated.
 3. All fire rated assemblies are subject to an upper live load limit of 250 psf.
 4. 3/4 in. diameter welded shear stud utilized for calculations.
 5. Refer to AISC for further stud material and installation requirements.

3VLI - 36in C-C

ALABAMA

7205 Gault Avenue N.
Fort Payne, AL 35967
P.O. Box 680169
Fort Payne, AL 35968
256/845-2460
Fax: 256/845-2823

INDIANA

6610 County Road 60
P.O. Box 1000
St. Joe, IN 46785
260/337-1800
Fax: 260/337-1801

NEBRASKA

1601 West Omaha Avenue
Norfolk, NE 68701
P.O. Box 59
Norfolk, NE 68702
402/644-8500
Fax: 402/644-8528

SOUTH CAROLINA

1501 West Darlington Street
P.O. Box 100520
Florence, SC 29501
843/662-0381
Fax: 843/662-3132

TEXAS

175 County Road 2345
P.O. Box 186
Grapeland, TX 75844
936/687-4665
Fax: 936/687-4290

UTAH

1875 West Highway 13 South
P.O. Box 637
Brigham City, UT 84302
435/734-9433
Fax: 435/723-5423

VULCRAFT OF NEW YORK

5362 Railroad Street
P.O. Box 280
Chemung, NY 14825
607/529-9000
Fax: 607/529-9001

VULCRAFT NATIONAL ACCOUNTS

6230 Shiloh Road
Suite 140
Alpharetta, GA 30005
678/455-6553
Fax: 678/455-9216

